

ABOX II Series

Compact POS Box System



User Manual

Before installing and operating the unit, please read this user manual thoroughly and retain for reference.

How to Use This Manual

This manual contains information to set up and use the ABOX II. In addition, instructions are included for added hardware, upgrades, software, and optional items.

- Chapter 1** An introduction to what you find in the ABOX II and an overview of product specifications, appearance, and interface.
- Chapter 2** Detailed installation information for the base unit and upgrades, including the HDD, main memory, and Compact Flash.
- Chapter 3** Mounting procedures for optional devices.
- Chapter 4** PEB-973H main board diagrams, locations of jumpers, and connectors.
- Chapter 5** Transfer board diagrams, locations of connectors, and connector pin definition.
- Chapter 6** Installation instructions for the Intel chip set driver, video driver, audio, LAN, AdvanPOS system and OPOS drivers.

**WARNING!**

Text set off in this manner indicates that failure to follow directions could result in bodily harm or loss of life.

**CAUTION:**

Text set off in this manner indicates that failure to follow directions could result in damage to equipment or loss of information.

**NOTE:**

Text set off in this manner provides important supplemental information.

Federal Communications Commission (FCC) Notice

This equipment has been tested and found to comply with the limits for a Class A digital device, pursuant to Part 15 of the FCC Rules. These limits are designed to provide reasonable protection against harmful interference in a residential installation.

This equipment generates, uses, and can radiate radio frequency energy and, if not installed and used in accordance with the instructions, may cause harmful interference to radio communications. However, there is no guarantee that interference will not occur in a particular installation. If this equipment does cause harmful interference to radio or television reception, which can be determined by turning the equipment off and on, the user is encouraged to try to correct the interference by one or more of the following measures:

- Reorient or relocate the receiving antenna.
- Increase the separation between the equipment and the receiver.
- Connect the equipment to an outlet on a circuit different from that to which the receiver is connected.
- Consult the dealer or an experienced radio/TV technician for help.



NOTE:

Shielded interconnect cables and shielded AC power cables must be employed with this equipment to insure compliance with pertinent RF emission limits governing this device. Changes or modifications not expressly approved by the system's manufacturer could void the user's authority to operate the equipment.

This device complies with Part 15 of the FCC Rules. Operation is subject to the following two conditions:

1. This device may not cause harmful interference.
2. This device must accept any interference received, including interference that may cause undesired operation.

Copyright

The information in this guide is subject to change without prior notice.

The manufacturer shall not be liable for technical or editorial errors or omissions contained herein, nor for incidental or consequential damages resulting from the furnishing, performance, or use of this material.

This manual contains information protected by copyright. No part of this manual may be photocopied or reproduced in any form without prior written consent from the manufacturer.

The software described in this guide is furnished under a license agreement or nondisclosure agreement. The software may be used or copied only in accordance with the terms of the agreement.

Product names mentioned herein may be trademarks and/or registered trademarks of their respective companies.

© 2010 All rights reserved.

First Edition March 2010

Patents and Trademarks

AdvanPOS trademark

Certificate No.: 01328466 (ROC patent)

Patent pending (European Union, Mainland China and USA)

Precautions

1. Please read these safety instructions carefully.
2. Keep this User Manual for later reference.
3. Disconnect this equipment from the AC outlet before cleaning. Do not use liquid or spray detergent for cleaning. Use only a moistened sheet or cloth.
4. For pluggable equipment, the socket outlet should be installed near the equipment and should be easily accessible.
5. Avoid humidity and moisture.
6. Install equipment on a stable surface.
7. Do not leave this equipment running in an enclosed or non-air-circulated environment, nor store in temperatures above 60°C. Such conditions may damage the equipment.
8. Ventilation openings on the unit are for air circulation and protect the equipment from overheating. DO NOT COVER THE OPENINGS.
9. Check the voltage of the power source before connecting the equipment to the power outlet.
10. Place the power cord so that it will not be stepped on. Do not place anything over the power cord. The power cord must be rated for the product and for the voltage and current marked on the product's electrical ratings label. The voltage and current rating of the cord should be greater than the voltage and current rating marked on the product.
11. All cautions and warnings on the equipment should be noted.
12. If the equipment is not used for a long time, disconnect the equipment from the power outlet to avoid damage.
13. Never allow any liquid into ventilation openings. This could cause fire or electrical shock.
14. Never open the equipment. For safety reasons, qualified service personnel should only open the equipment.
15. If one of the following situations may arise, get the equipment checked by qualified service personnel:
 - a. The power cord or plug is damaged.
 - b. Liquid has penetrated the equipment.
 - c. The equipment has been exposed to moisture.
 - d. The equipment does not work well or you cannot get it work according to the user manual.
 - e. The equipment has been dropped and damaged.
 - f. The equipment has obvious signs of damage.



WARNING! Not intended for outdoor use.



CAUTION: Danger of explosion if battery is incorrectly replaced. Replace only with same type, and discard used batteries according to manufacturer's instructions.

Contents

How to Use This Manual

Federal Communications Commission (FCC) Notice

Copyright

Patents and Trademarks

Precautions

Chapter 1 Introduction..... 1

Features..... 1

Specifications..... 1

Package Contents 3

Base System..... 4

Dimensions..... 5

ABOX-201-1(ABOX-2120) Connector Panel..... 6

Chapter 2 Standard Hardware and Upgrades 7

Precautions 7

Removing System Box Cover..... 8

Clearing CMOS..... 10

Compact Flash Card Installation 11

Memory Installation..... 13

Removing and Replacing the Hard Disk (RAID function support) 15

Add On Card Installation..... 18

Chapter 3 Optional Components and Peripherals 21

Wall Mount Kit Installation 21

Chapter 4 PEB-973H Main Board Configuration 22

Jumper and Connector Locations..... 22

Connector Pin Assignments..... 24

Jumper Settings..... 32

Chapter 5 Transfer Boards and I/O Ports Configuration 35

Powered USB Board: Connector Allocation..... 35

LVDS to VGA Transfer Board: Connector Allocation 36

External 2nd VGA Port: Connector Pin Definitions 36

Chapter 6 Software Setup 37

Pre-Installation Requirements 37

Intel Chipset Driver Installation 39

Intel Graphics Driver Installation 40

Audio Driver Installation 41

Ethernet Driver Installation 錯誤! 尚未定義書籤。

AdvanPOS System Driver Installation (required for Cash Drawer) 43

OPOS CCO Driver Installation 44

AdvanPOS OPOS Driver Installation 46

Appendix A. Sample C++ Cash Drawer Code for Windows..... 47

Appendix B. Sample VB.NET Cash Drawer Code for Windows..... 49

Appendix C. Sample VB6.0 Cash Drawer Code for Windows 51

Chapter 1 Introduction

Features

- Robust aluminum housing
- Support DDR3 Technology
- Support RAID 0/1/JBOD
- Supports Dual VGA output and Giga LAN
- 5 x COM, 9 x USB, 1 x CF II
- One RJ11 12VDC port for Cash Drawer
- PCI / PCIe Expansion Slot
- RoHS compliant

Specifications

ABOX-2120 (ABOX-201-1) System Configuration

CPU	Intel® Atom™ Luna Pier Dual Core Processor 1.8GHz w/ 1MB L2 Cache fanless
System Chipset	Intel D525+ICH8M
System Memory	Supports maximum 4GB with DDR3 1333 MHz SO-DIMM
Video Memory	Supports Intel DVMT, shared system memory
Compact Flash	Supports 1 x Compact Flash Card Type II
HDD	1 x internal 2.5" 160GB SATA hard disk drive (up to 250GB)
Power	AC input, 120W PSU embedded
OS Support	Windows® XP Pro Embedded / WEPOS® / Windows® POS Ready 2009 / Linux® / Windows® 7 Pro Embedded

I/O Ports

Serial Ports	ABOX-201-1 (ABOX-2120)	5 external: COM1/2/5/6 D-SUB pin 9 with +5V/+12V and COM4
	ABOX-201-1DV (ABOX-2120-DV)	4 external: COM1/2/5 D-SUB pin 9 with +5V/+12V and COM4
VGA Port	ABOX-201-1 (ABOX-2120)	1 x VGA port (D-SUB15)
	ABOX-201-1DV (ABOX-2120-DV)	2 x VGA ports (D-SUB15)
PS/2		1 x Keyboard
USB Ports		Supports 9 USB 2.0 ports for future expansion (front x 2, rear x 7) <ul style="list-style-type: none">- 6 x Normal USB ports- 2 x 12V powered USB ports- 1 x 24V powered USB ports
Parallel Port		1 x bi-directional parallel port (D-SUB25)
Cash Drawer Port		1 x 12V RJ11 connector (maximum 2 drawers)
LAN Port		1 x Giga LAN (10/100/1000Mbps Base-T), RJ45 connector
Audio Port		1 x Line-out, 1 x Mic-in

Extendable Slot (optional)	1 x PCI Slot 1 x PCIe Slot
Power Output	1 x 12V Power Jack Output 1 x 24V Power Jack Output

Mechanics and Environment

Construction	Aluminum enclosure
Dimensions	275(L) x 346(W) x100(H) mm
Housing Color	Red/Black and Black
Net Gross Weight	6 Kg
Operating Temperature	0 °C ~ 40 °C
EMI/Safety	CE, FCC, RoHS



NOTE:

The Max of 12V output : 3.6A for 2 x 12V Powered USB and 1 x 12V DC output
The Max of 24V output : 2.5A for 1 x 24V Powered USB and 1 x 24V DC output

Package Contents

The following items come standard with the ABOX II (ABOX-2120) series:

<p>POS System</p>		<p>AC Power Cord</p>	
<p>Utility and Main Board Chipset Driver CD</p>		<p>Wall Mount Kit and Mounting Accessory (optional)</p>	

Options for ABOX II

- Model LM-150 series and LM-170 series POS monitor
- Model H-2120 Dual VGA Monitor 1024 x 768 500 nits with Touch
- Model H-2150 Dual LVDS Monitor 1024 x 768 250 nits (expandable functions as below)
- Touch panel (COM type)
- Magnetic Stripe Reader (MSR) Module: triple track*
- 2-in-1 Module (Magnetic Stripe Reader + Fingerprint Reader) *
- 2-in-1 Module (Magnetic Stripe Reader + I-Button Reader) *
- 3-in-1 Module (Magnetic Stripe Reader + I-Button Reader + IC Card Reader) *
- Wireless Module: WiFi 802.11b/g or Bluetooth 2.0
- Radio Frequency Identification (RFID) Module: internal 13.56MHz
- LCM Customer Display: 4 lines 30 columns each (pole-type)
- VFD Customer Display: 9 mm height, 2 lines 20 characters each (rear mount type)

* Available in front or side swipe formats.

Base System

Before you begin, take a few moments to become familiar with the ABOX-201-1 (ABOX-2120) series. Exterior I/O ports may vary according to model versions.

Front Side View

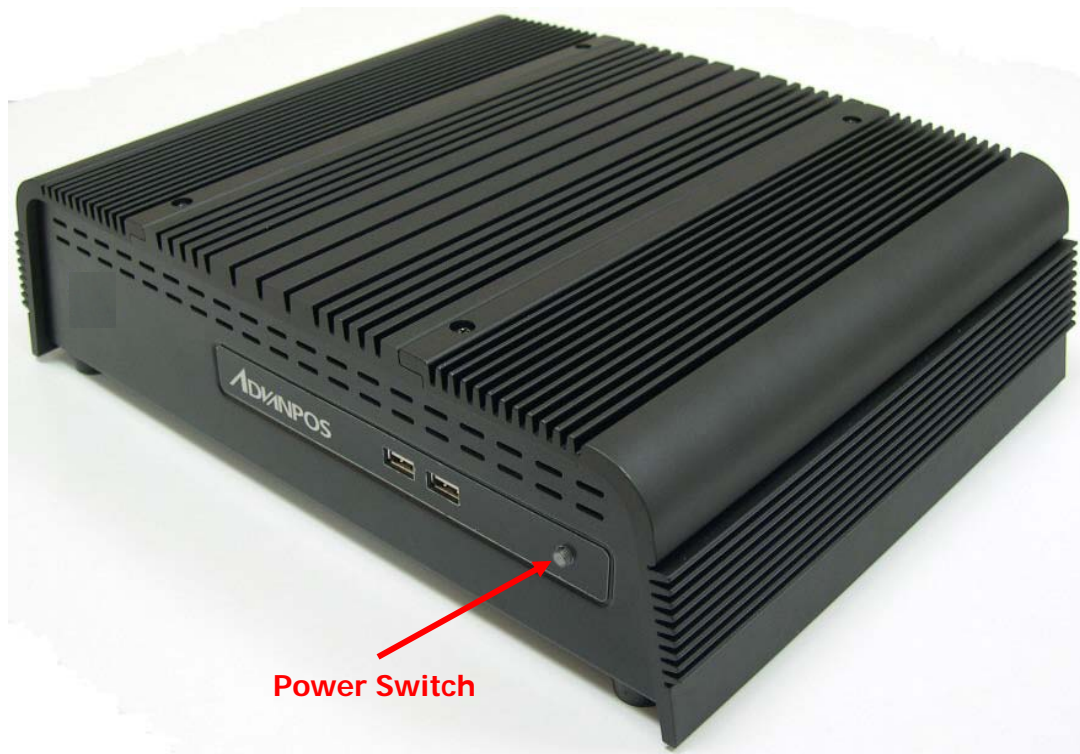

Rear Side View

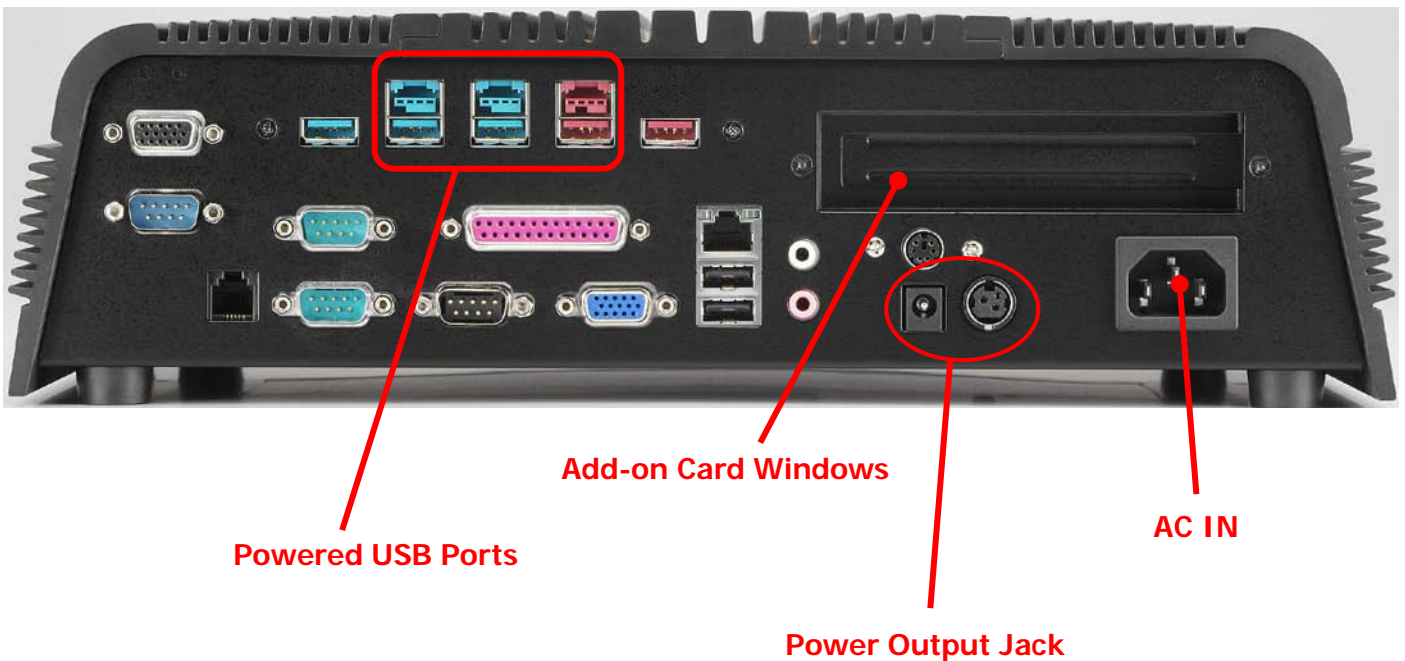

Dimensions

(Unit: mm)

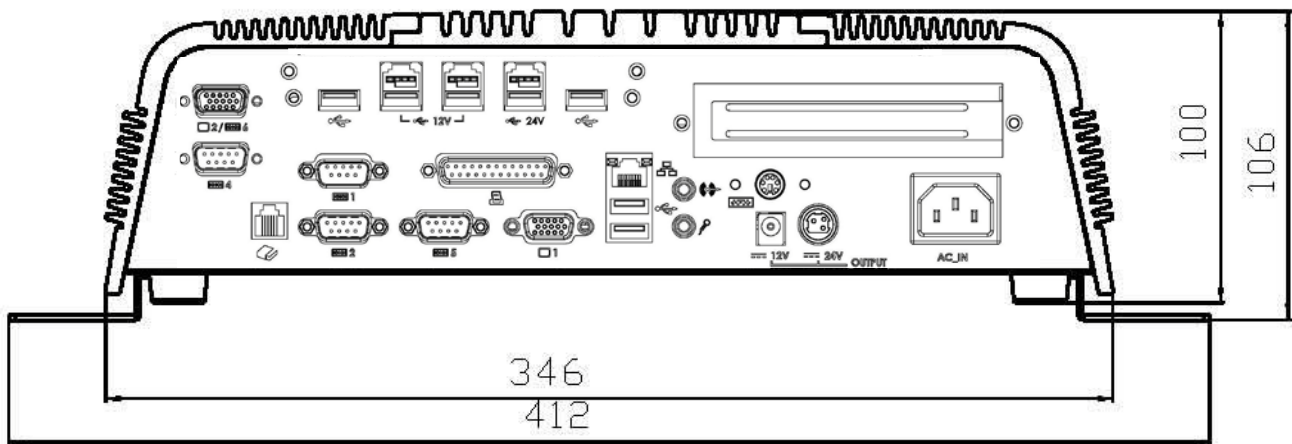
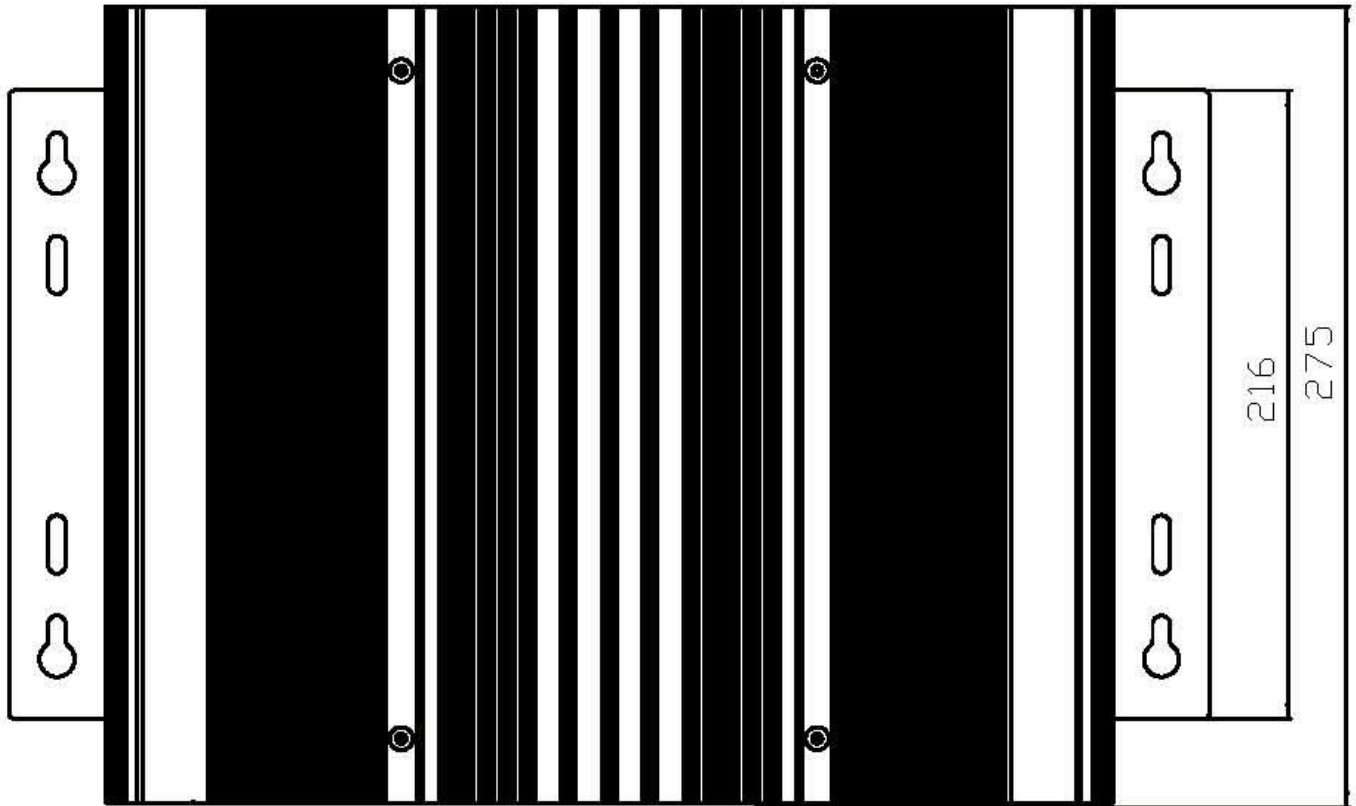

ABOX-201-1(ABOX-2120) Connector Panel

The ABOX-201-1(ABOX-2120)'s primary connector panel is located at the rear.

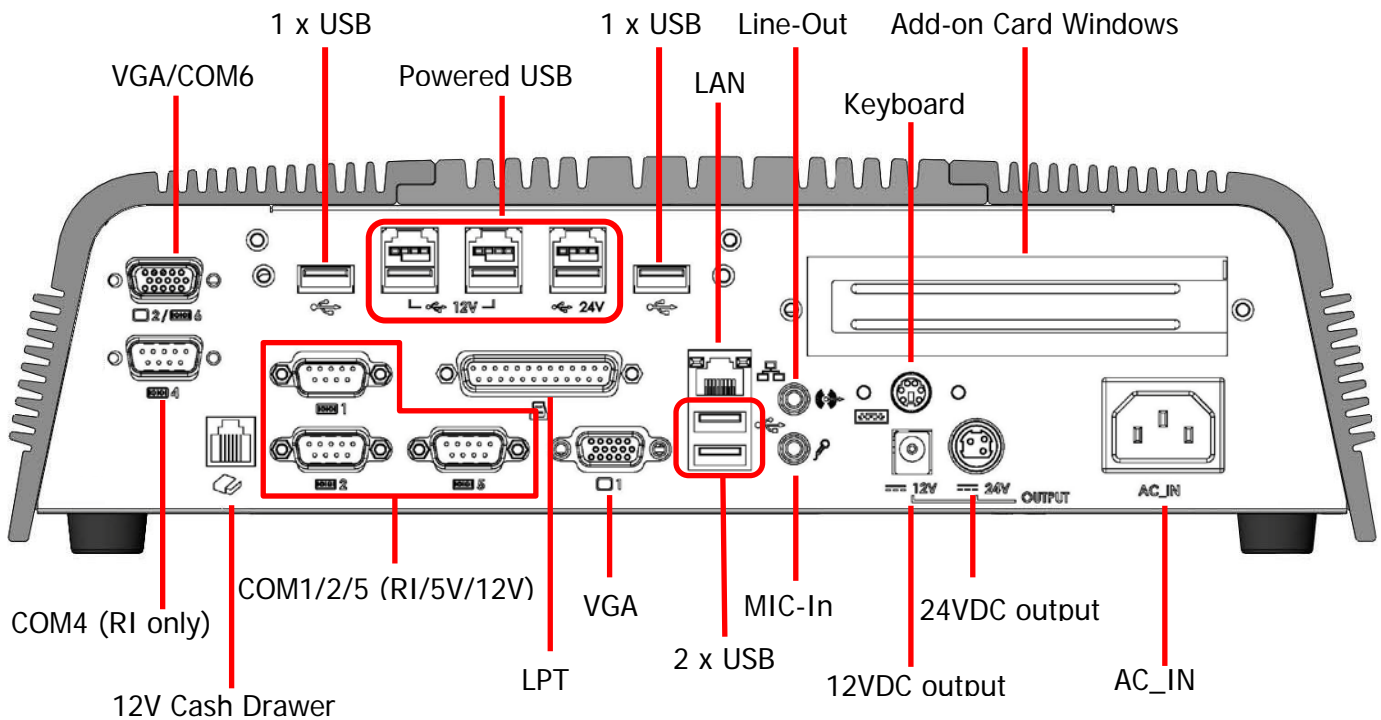

NOTE:

The 2nd VGA port's signals are come from a LVDS to VGA transfer board. Please refer to Chapter 5 for the 2nd VGA port pin assignment.

Chapter 2 Standard Hardware and Upgrades

Precautions

Before performing hardware changes, be sure to carefully read all of the applicable instructions, cautions, and warnings in this guide.



WARNING!

To reduce the risk of personal injury from electrical shock, hot surfaces, or fire:

Disconnect the power cord from the wall outlet and allow the internal system components to cool before touching.

Do not plug telecommunications or telephone connectors into the network interface controller receptacles.

Do not disable the power cord grounding plug. The grounding plug is an important safety feature.

Plug the power cord in a grounded (earthed) outlet that is easily accessible at all times.



CAUTION:

Static electricity can damage the electrical components of the computer and/or optional equipment. Before beginning these procedures, ensure that you are discharged of static electricity by briefly touching a grounded metal object.

When the computer is plugged into an AC power source, voltage is always applied to the main board. You must disconnect the power cord from the power source before opening the unit to prevent damage to internal components.

Removing System Box Cover



CAUTION:

To prevent loss of work and damage to the system or drive:

If you are inserting or removing a drive, shut down the operating system properly, turn off the system, and unplug the power cord. Do not remove a drive while the system is on or in standby mode.

Before handling a drive, ensure that you are discharged of static electricity. While handling a drive, avoid touching the connector.

1. Turn off the system power properly through the operating system, then turn off any external devices.
2. Disconnect the power cord from the power outlet and disconnect any external devices.
3. Place the main unit upside down, and then remove the six screws indicated on the bottom of system box.

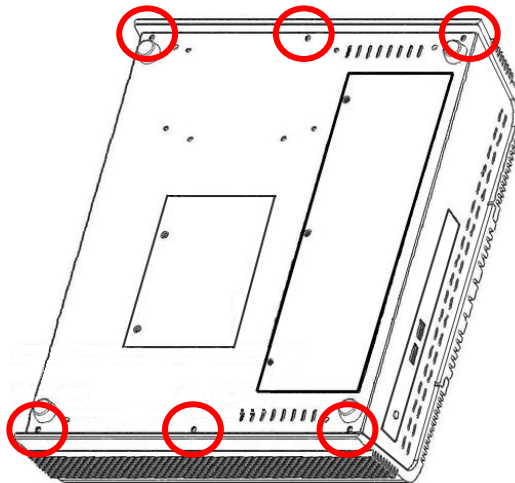

4. Set the main unit back to an upright position, and then remove the four screws indicated on the top of system box.



5. Remove the right side cover and the left side cover.

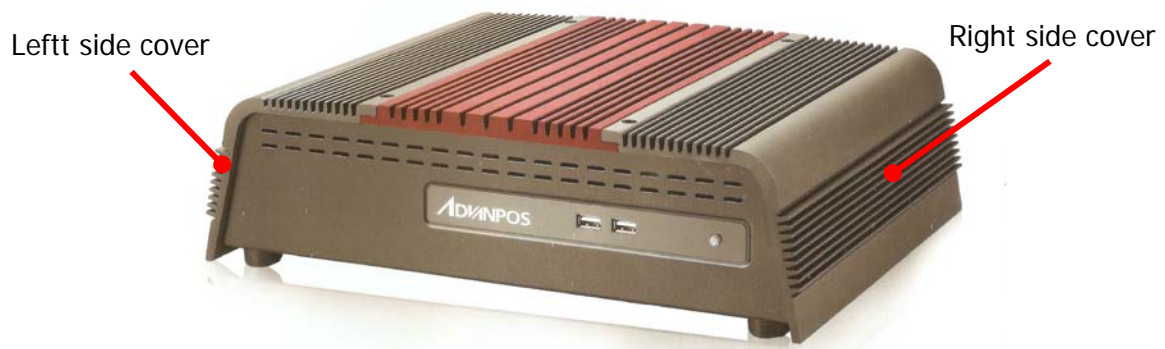

6. Remove the four screws indicated on the top of system box.

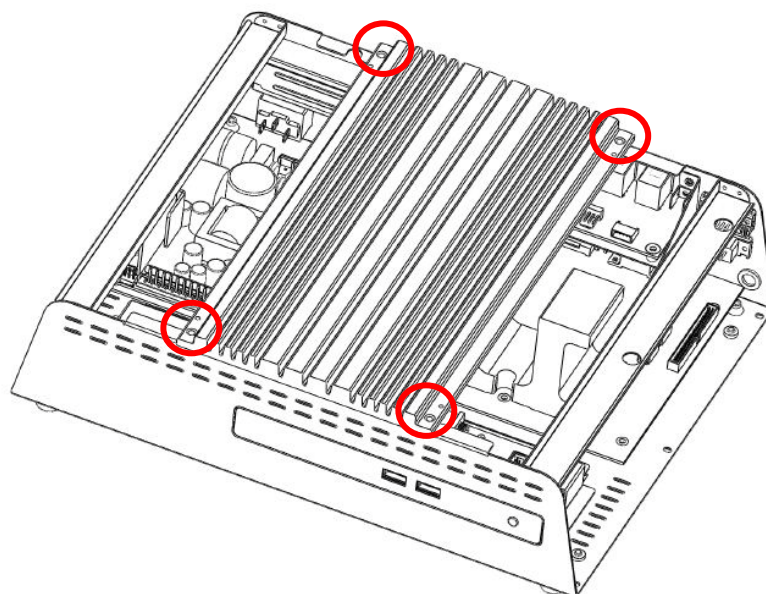

Clearing CMOS

The ABOX-201-1 (ABOX-2120) 's configuration (CMOS) may occasionally be corrupted. If it is, it will be necessary to clear the CMOS memory using jumper JP1. Please refer to Chapter 4 for the exact JP1 pin positions.

1. Turn off the system power properly through the operating system, then turn off any external devices.
2. Disconnect the power cord from the power outlet and disconnect any external devices.



CAUTION:

Regardless of the power-on state, voltage is always present on the main board as long as the system is plugged into an active AC outlet. The power cord must be disconnected from the power source before clearing the CMOS.



NOTE:

All LEDs on the board should be OFF. Failure to ensure there is no power in the system may damage the main board. You must disconnect the power cord to avoid damage to the internal components of the system.

3. Open the system box cover.
4. Locate the JP1 jumper box on the main board.
5. Remove the jumper shunt from pins 1-2 and place over pins 2-3.
6. Wait 60 seconds to allow the CMOS to clear, then remove the jumper shunt and place it back in its original position over pins 1-2.
7. Reattach the system box cover.

Compact Flash Card Installation

1. Turn off the system power properly through the operating system, then turn off any external devices.
2. Disconnect the power cord from the power outlet and disconnect any external devices.



CAUTION:

Regardless of the power-on state, voltage is always present on the main board as long as the system is plugged into an active AC outlet. You must disconnect the power cord to avoid damage to the internal components of the system.

3. Place the main unit upside down. Remove the two screws indicated at the bottom of the base and lift off the CF cover in the direction of the arrow.

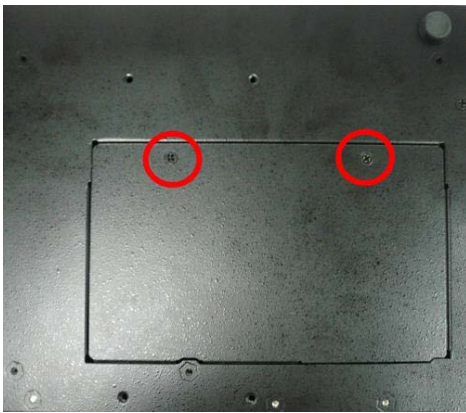

4. Insert the CF card into the socket.



NOTE:

Grooves on both sides of the CF card should exactly match those on the socket, simplifying CF card installation.

5. Replace the CF cover and set the box back to an upright position.
6. Reconnect the power cord and any external devices, then turn on the system. The system should automatically recognize the CF card when the system power is turned on.

**NOTE:**

CF card and 2.5" HDD master/slave setting:

The system allows the use of both the CF card and hard disk at the same time, however the user will need to set the system BIOS for the preferred boot order. When either a CF card only or 2.5" hard disk only is installed, the BIOS will automatically designate it as the 'master' drive and system boot device.

Memory Installation

The memory sockets on the main board can be populated with an industry-standard DDR3 DIMM. The ABOX-201-1(ABOX-2120) comes standard with one preinstalled DIMM. To achieve maximum memory performance, up to 4GB of memory can be installed.



CAUTION:

You must disconnect the power cord and wait approximately 30 seconds for the power to drain before adding or removing memory cards. Regardless of the power-on state, voltage is always supplied to the memory modules as long as the system is plugged into an active AC outlet. Adding or removing memory modules while voltage is present may cause irreparable damage to the memory modules or main board. If you see an LED light on the main board, voltage is still present.

The memory module sockets have gold-plated metal contacts. When upgrading the memory, it is important to use memory modules with gold-plated metal contacts to prevent corrosion and/or oxidation resulting from having incompatible metals in contact with each other.

Static electricity can damage the electronic components of the system or optional cards. Before beginning these procedures, ensure that you are discharged of static electricity by briefly touching a grounded metal object.

When handling a memory module, be careful not to touch any of the contacts. Doing so may damage the module.

-
1. Turn off the system power properly through the operating system, and then turn off any external devices.
 2. Disconnect the power cord from the power outlet and disconnect any external devices.



CAUTION:

Regardless of the power-on state, voltage is always present on the main board as long as the system is plugged into an active AC outlet. You must disconnect the power cord to avoid damage to the internal components of the system.



WARNING!

To reduce risk of personal injury from hot surfaces, allow the internal system components to cool before touching.

-
3. Place the system box upside down. Remove the two screws indicated on the bottom of the box and lift off the CF cover in the direction of the arrow.

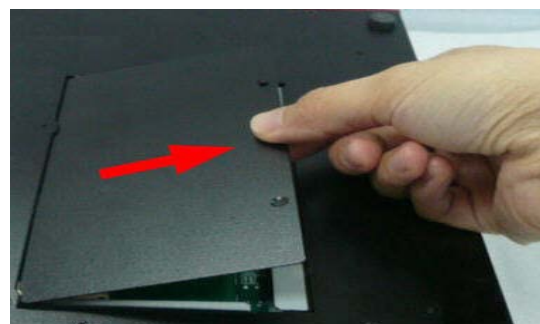
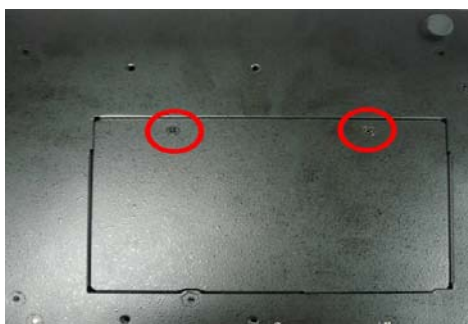

4. If an existing memory card or cards need to be replaced, pull the ends of both metal latches away from the card to release it.



NOTE:

A memory card can be installed in only one way. Match the notch on the card with the tab in the memory socket.

5. Insert the additional or replacement memory card into the socket, almost covering the gold contacts completely, then push the card down. If the card is fully inserted and properly seated, the metal latches will be in the closed position indicated.



6. Replace the CF cover and set the box back to an upright position.
7. Reconnect the power cord and any external devices, and then turn on the system. The system should automatically recognize the additional memory when powered up.

Removing and Replacing the Hard Disk (RAID function support)

ABOX-201-1 (ABOX-2120) series support RAID 0/1/JBOD function. SW2 is H/W RAID Mode selection and default is set as RAID 1 functionality.

Should you want to change the RAID mode, please turn SW2 to "0" then power on/off the system once, and turn SW2 to position you wanted. Otherwise, you can also configure RAID and monitor the status of the disks connected via HW RAID Manager Tool in Windows mode. The HW RAID Manager Tool and user guide were put under driver CD.



NOTE:

This system does not support Parallel ATA (PATA) hard drives.

Before removing the original hard drive, be sure to back up its data so that you can transfer the data to the replacement hard drive. Also, if you are replacing the primary hard drive, make sure you have a recovery disc set to restore the operating system, software drivers, and any software applications that were preinstalled on the system.

-
1. Turn off the system power properly through the operating system, and then turn off any external devices.
 2. Disconnect the power cord from the power outlet and disconnect any external devices.



CAUTION:

Regardless of the power-on state, voltage is always present on the main board as long as the system is plugged into an active AC outlet. You must disconnect the power cord to avoid damage to the internal components of the system.

-
3. Place the system box upside down. Remove three screws that secure the HDD cover, and carefully remove it from the system box .

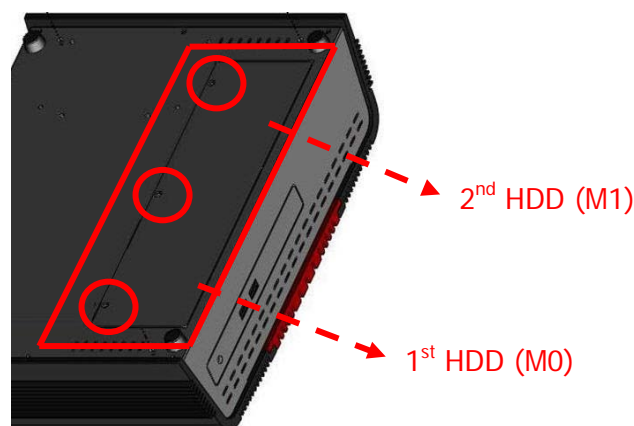

4. From the side of the HDD box, remove screws that secures the HDD box.



5. Push the bar of HDD box in the direction of the arrow. Next, lift up the HDD box and remove it.



6. From the bottom of the HDD box, remove all four screws and lift out the hard disk.

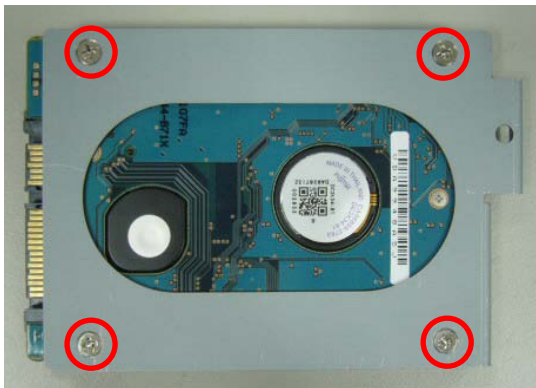

7. Insert the replacement hard disk into the HDD box, and re-secure the screws.
8. Place the HDD cover back into the system box and then re-secure the hard disk with screws.
9. Reattach the three screws that secure the HDD cover.
10. Reconnect the power cord and any external devices, then turn on the system.

**CAUTION:**

When only one HDD device (placed on M0) is installed in ABOX-201-1 (ABOX-2120), the system will recognize the M0 (1st HDD) device as a normal SATA HDD application. In this case, please DO NOT insert any HDD device onto M1 location (2nd HDD), or the M0 data will be lost.

If you would like to enable RAID 1 functionality to ABOX-201-1 (ABOX-2120), it is mandatory that you place two empty HDD devices at M0 and M1 location first, and then install the OS and HW RAID Manager tool to monitor the RAID functionality status. When either one of the HDD devices has a bad sector, the buzzer will sound to give an alarm.

If you would like to change the RAID mode, please place two empty HDD devices at M0 and M1 location and turn SW2 to “0” , power on/off the system once, and then turn SW2 to the required position.

**NOTE:**

The capacity of a sector is 4096 bytes for 320GB HDD of WD. They are only suitable for Win7 or OS developed later than Win7. To use Microsoft earlier OS such as XP, POS Ready2009 , You should install support tools offered by original supplier to align the performance of HDD. Otherwise HDD life will be reduced about 48%. You can get the alignment tool from following website or driver CD included in the package.

WD Alignment tool: <http://support.wdc.com/product/downloadsw.asp?sid=128>

Add On Card Installation

1. Turn off the system power properly through the operating system, then turn off any external devices.
2. Disconnect the power cord from the power outlet and disconnect any external devices.



CAUTION:

Regardless of the power-on state, voltage is always present on the main board as long as the system is plugged into an active AC outlet. You must disconnect the power cord to avoid damage to the internal components of the system.

3. Remove the four screws indicated on the top of system box.



4. Remove the right side cover and the left side cover.



5. Remove the four screws indicated on the top of system box.

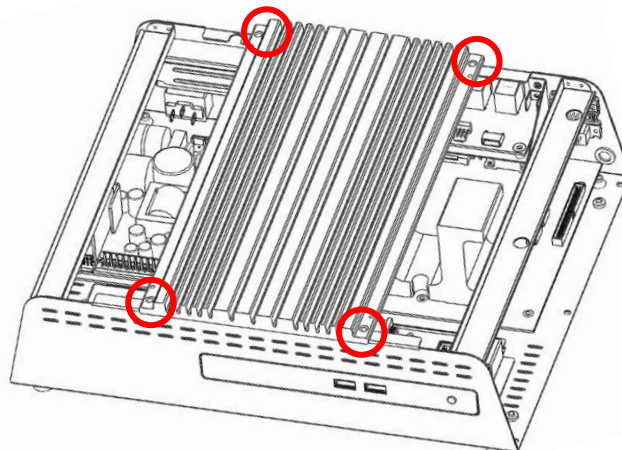

6. Remove a screw indicated on the left side of system box to remove the bracket.

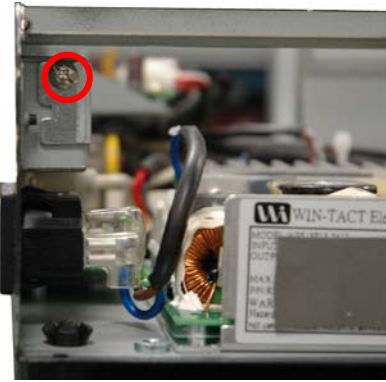

7. Insert the riser card into the socket, almost covering the gold contacts completely, then push the card down.



Riser CARD

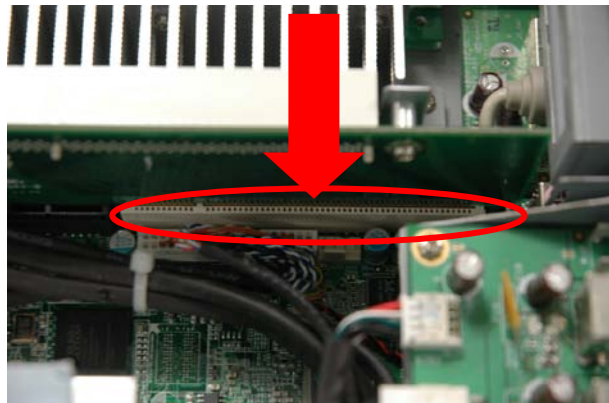

8. Screw the riser card with four screws.

9. Insert the add-on card into the socket, almost covering the gold contacts completely, then push the card down.

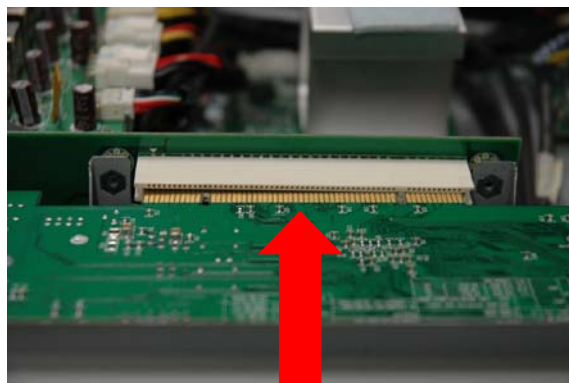

10. Screw the add-on card with a screw.

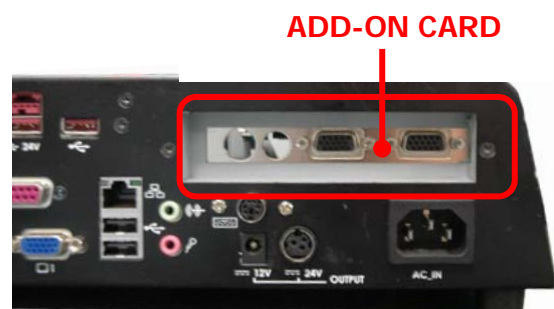

11. Reattach the eight screws that secure the cover.
12. Reconnect the power cord and any external devices, then turn on the system. The system should automatically recognize the CF card when the system power is turned on.

Chapter 3 Optional Components and Peripherals

Wall Mount Kit Installation

Select a flat surface on a wall of adequate strength, ensuring there will be proper ventilation and maneuvering space. Please use the right tools and accessories according to the wall material (drywall, concrete, solid wood, etc.) to securely support the system box. A fully equipped system may weigh up to 7 kg.

1. Secure the two mounting brackets to the main unit with four screws.

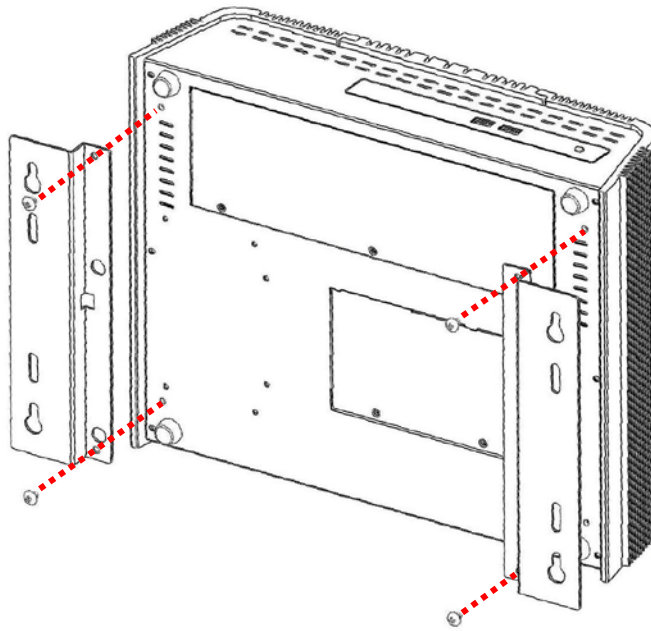

2. In accordance with the layout as shown below, drill four holes in the wall. The rectangular drill pattern should be 379.2mm wide (horizontal) and 166mm high (vertical). Secure the unit to the wall with four screws.

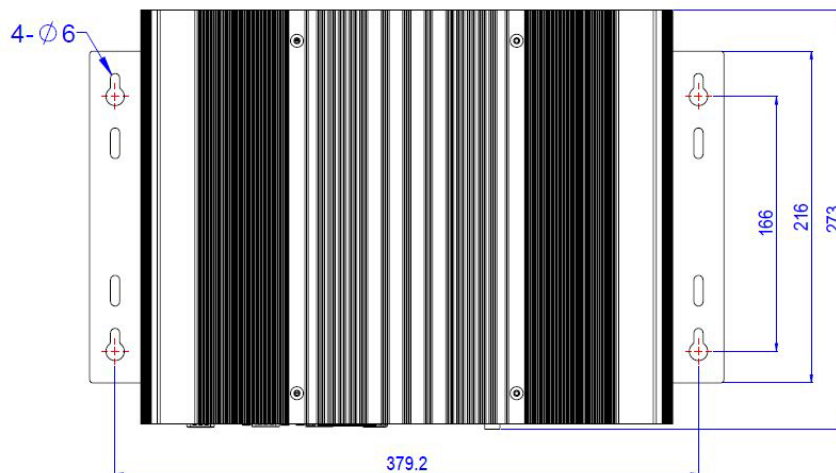

NOTE:

Wall mounting screws are not supplied, as different types of walls require different types of screws. Please be sure the mounting screws used can support the weight of the unit.

Chapter 4 PEB-973H Main Board Configuration

Jumper and Connector Locations

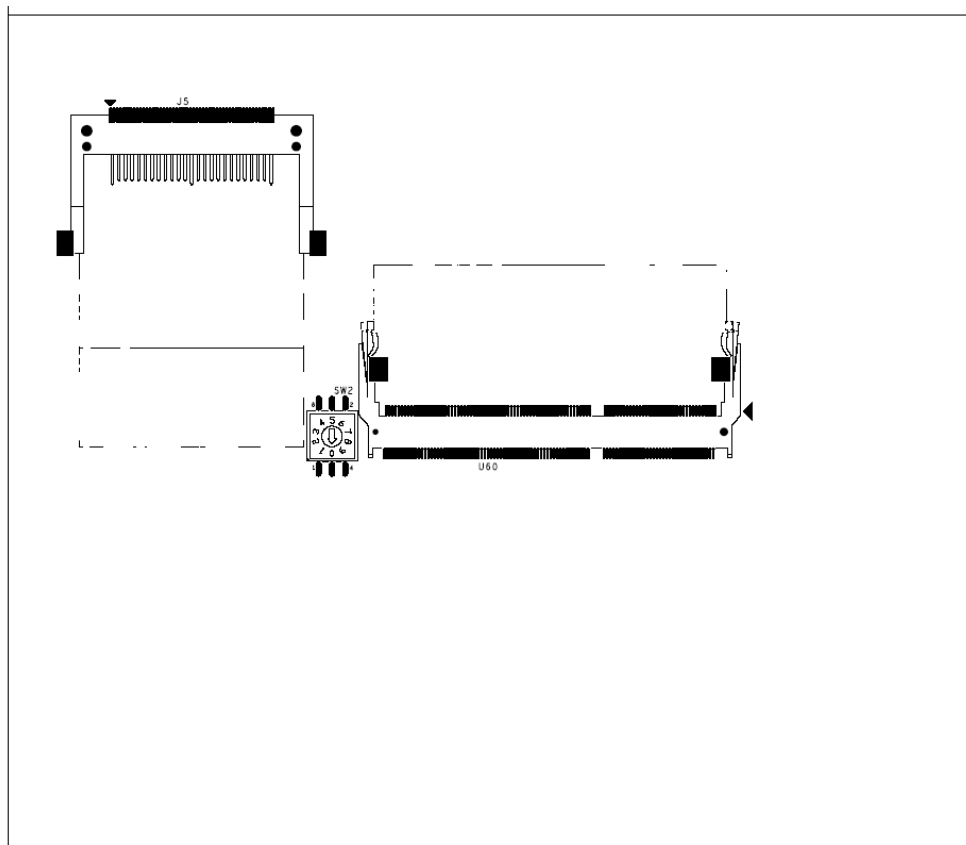
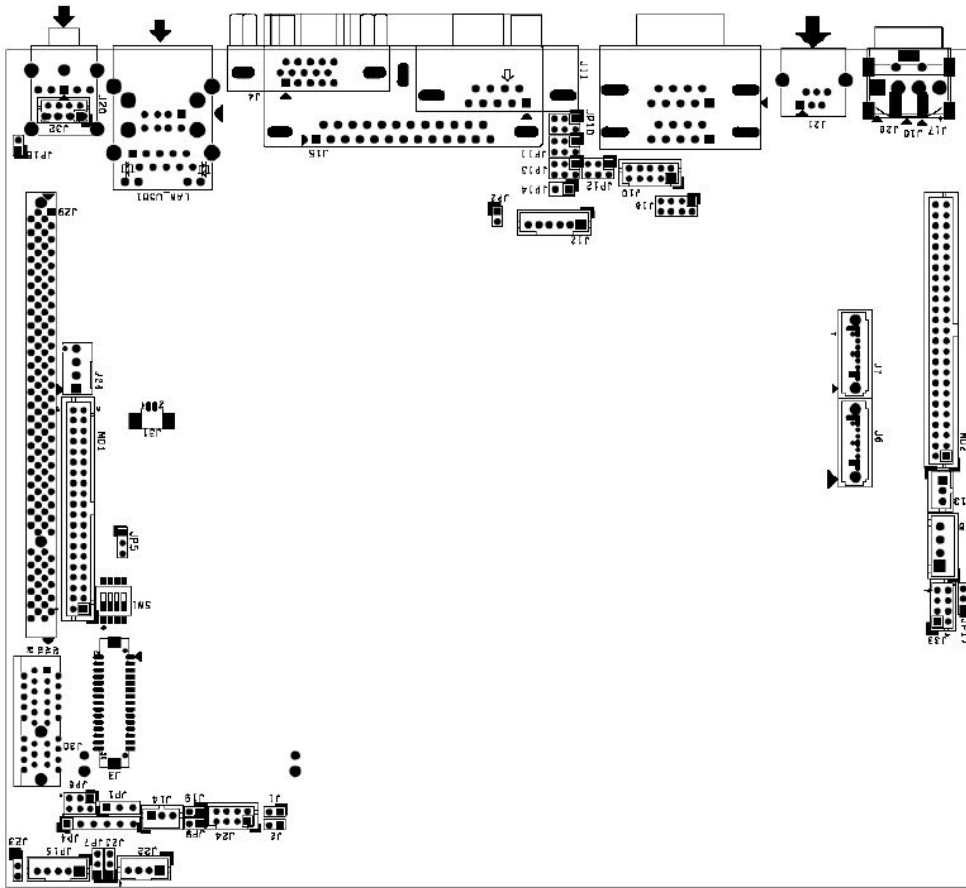

Connector Allocation

Connector	Function
J3	LVDS Connector
J4	VGA Connector
J5	Compact Flash Connector
J6,J7	SATA Connector
J8	SATA Power Connector
J9	COM1 & COM2 Connector
J10	COM6 Port Pin Header
J11	COM5 Port Connector
J12	PS/2 Keyboard/Mouse Connector
J13	CPU FAN
J14	SYS FAN
J15	Print Port Connector
J16	POWER DC +12V Connector
J17	POWER DC +12V Connector
J18	Front panel pin header
J19	HDD LED Pin header
J20	AUDIO JACK Connector
J21	CASH DRAWER Interface Connector
J22	External USB Pin Header
J24	External USB Pin Header
J26	12V Output Connector
J28	POWER DC +12V Power Header
J29	PCI SLOT
J30	PCI-E x1 SLOT
J31	Battery pin header
J32	AUDIO Pin Header
JP2	CASE OPNE Pin Header
JP4	XC3S200A JTAG
JP15	BACK LIGHT PWR Connector

Connector Pin Assignments

J3

LVDS Connector

PIN No.	Description	PIN No.	Description
1	LVDS VDD	2	KICK-OUT1
3	LCD1DO0+	4	LCD1DO0+
5	LCD1DO1+	6	LCD1DO1-
7	LCD1DO2+	8	LCD1DO2-
9	LCD1DO3+	10	LCD1DO3-
11	LCD1CLK+	12	LCD1CLK-
13	LDDC_CLK	14	LDDC_DATA
15	GND	16	GND
17	LCD2DO0+	18	LCD2DO0-
19	LCD2DO1+	20	LCD2DO1-
21	LCD2DO2+	22	LCD2DO2-
23	LCD2DO3+	24	LCD2DO3-
25	LCD2CLK+	26	LCD2CLK-
27	NC	28	NC
29	GND	30	GND

J10

COM6 Port Pin Header

PIN No.	Description	PIN No.	Description
1	DCD#	2	DSR#
3	RXD#	4	RTS#
5	TXD#	6	CTS#
7	DTR#	8	RI (Voltage)
9	GND	10	GND

J12

PS/2 Keyboard/Mouse Pin Header

PIN No.	Description
1	L_KCLK
2	L_MDAT
3	L_KDAT
4	KBVCC
5	L_MCLK
6	GND

J13/J14**CPU & SYS 12V DC Fan Connector**

PIN No.	Description
1	GND
2	+12V
3	FAN Control

J15**Print Port Connector**

PIN No.	Description	PIN No.	Description
1	P_STB-	2	P_PD0
3	P_PD1	4	P_PD2
5	P_PD3	6	P_PD4
7	P_PD5	8	P_PD6
9	P_PD7	10	ACK-
11	BUSY	12	PE
13	SLCT	14	P_AFD-
15	ERR-	16	P_INIT-
17	P_SLIN-	18	GND
19	GND	20	GND
21	GND	22	GND
23	GND	24	GND
25	GND		

J16**POWER DC +12V Connector**

PIN No.	Description
1	+12V
2	GND
3	+12V

J18**Front Panel Pin Header**

PIN No.	Description	PIN No.	Description
1	SUS_LED+	2	SUS_LED-
3	Power_LED+	4	Power_LED-
5	GND	6	SYS_Reset
7	Power Switch	8	GND

J19**HDD LED Pin Header**

PIN No.	Description
1	HDD_LED+
2	HDD_LED-

J21**Cash Drawer Interface Connector**

PIN No.	Description	PIN No.	Description
1	GND	2	KICK-OUT1
3	IN-SENSE	4	+12V
5	KICK-OUT2	6	GND

J22**External USB Pin Header**

PIN No.	Description
1	USB power (5VSB)
2	USB DATA A-
3	USB DATA A+
74	GND

J24**External USB Pin Header**

PIN No.	Description	PIN No.	Description
1	USB power	2	USB power
3	USB DATA A-	4	USB DATA B-
5	USB DATA A+	6	USB DATA B+
7	GND	8	GND

J26**+12V Output Connector**

PIN No.	Description
1	+12V
2	+12V
3	GND
4	GND

J28**Power DC +12V Power Header**

PIN No.	Description
1	GND
2	GND
3	+12V
4	+12V

J29**PCI SLOT**

PIN No.	Description	PIN No.	Description
B1	NC	A1	TRST#
B2	TCK	A2	+12V
B3	GND	A3	TMS
B4	NC	A4	TDI
B5	5V	A5	5V
B6	5V	A6	INTA#
B7	INTB#	A7	INTC#
B8	INTD#	A8	5V
B9	PRSENT1#	A9	GNT1#
B10	RSV	A10	5V
B11	PRSENT2#	A11	NC
B12	GND	A12	GND
B13	GND	A13	GND
B14	CLOCK1	A14	3V_DUAL
B15	GND	A15	PCI_RESET#
B16	CLOCK0	A16	5V
B17	CND	A17	GNT0#
B18	REQ0#	A18	GND
B19	5V	A19	ICH_PME#
B20	AD31	A20	AD30
B21	AD29	A21	3.3V
B22	GND	A22	AD28
B23	AD27	A23	AD26
B24	AD25	A24	GND
B25	3.3V	A25	AD24
B26	C/BE3#	A26	IDSEL
B27	AD23	A27	3.3V
B28	GND	A28	AD22
B29	AD21	A29	AD20
B30	AD19	A30	GND
B31	3.3V	A31	AD18
B32	AD17	A32	AD16

B33	C/BE2	A33	3.3V
B34	GND	A34	FRAME#
B35	IRDY#	A35	GND
B36	3.3V	A36	TRDY#
B37	DEVSEL#	A37	GND
B38	GND	A38	STOP#
B39	PLOCK#	A39	3.3V
B40	PERR#	A40	SMBCLK
B41	3.3V	A41	SMBDAT
B42	SERR#	A42	GND
B43	3.3V	A43	PAR
B44	C/BE1#	A44	AD15
B45	AD14	A45	3.3V
B46	GND	A46	AD13
B47	AD12	A47	AD11
B48	AD10	A48	GND
B49	GND	A49	AD9
B52	AD8	A52	C/BE0#
B53	AD7	A53	3.3V
B54	3.3V	A54	AD6
B55	AD5	A55	AD4
B56	AD3	A56	GND
B57	GND	A57	AD2
B58	AD1	A58	AD0
B59	5V	A59	5V
B60	ACK64#	A60	REQ64#
B61	5V	A61	5V
B62	5V	A62	5V

J30

PCI-Ex1 SLOT

PIN No.	Description	PIN No.	Description
B1	+12V	A1	PRSNT#
B2	+12V	A2	+12V
B3	NC	A3	+12V
B4	GND	A4	GND
B5	SMB_CLK_MAIN	A5	NC
B6	SMB_CLK_MAIN	A6	NC
B7	GND	A7	NC
B8	+3.3V	A8	NC
B9	NC	A9	+3.3V
B10	+3.3VAUX	A10	+3.3V
B11	WAKE#	A11	RESET#

B12	NC	A12	GND
B13	GND	A13	PCIE_CLK+
B14	PCIE_TX+	A14	PCIE_CLK-
B15	PCIE_TX-	A15	PCIE_RX+
B16	NC	A16	PCIE_RX-
B17	CND	A17	GND

J32

AUDIO Pin Header

PIN No.	Description	PIN No.	Description
1	Line out-R	2	MIC-R
3	SE/BTL Control	4	Ground -
5	Ground	6	MIC-L
7	Line out-R	8	Ground

JP2

Case Open Pin Header

PIN No.	Description
1	CASE OPEN#
2	GND

JP4

XC3S200AJTAG

JP1	Function
1	+V3.3
2	GND
3	TCK
4	TDO
5	TDI
6	TMS

JP15

BLACK LIGHT PWR Connector

PIN No.	Description
1	VCC
2	GND
3	+12V
4	GND
5	ENABLE

MD1**Multi Purpose Port1 Connector**

PIN No.	Description	PIN No.	Description
1	AMP_L+	2	LVDS BKL TEN
3	AMP_L-	4	+12V
5	Gnd	6	+12V
7	Gnd	8	+12V
9	VDD_LVDS	10	LVDS Adjust
11	VDD_LVDS	12	Gnd
13	LVDS DATAP0	14	Gnd
15	LVDS DATAN0	16	Gnd
17	LVDS DATAP1	18	USB DATA5P
19	LVDS DATAN1	20	USB DATA5N
21	LVDS DATAP2	22	Gnd
23	LVDS DATAN2	24	USB DATA6P
25	LVDS DATAP3	26	USB DATA6N
27	LVDS DATAN3	28	Gnd
29	LVDS CLKP	30	USB DATA4P
31	LVDS CLKN	32	USB DATA4N
33	Gnd	34	+5V
35	Gnd	36	+5V
37	Gnd	38	K/B DATA
39	Gnd	40	K/B CLK

MD2**Multi Purpose Port2 Connector**

PIN No.	Description	PIN No.	Description
1	AMP_R+	2	+5V
3	AMP_R-	4	+5V
5	SATA TXP0	6	+5V
7	SATA TXN0	8	+5V
9	GND	10	+5V
11	SATA RXP0	12	+5V
13	SATA RXN0	14	+12V
15	GND	16	+12V
17	TXD#3	18	CTS#3
19	RXD#3	20	DSR#3
21	RTS#3	22	DTR#3
23	Power On Switch	24	GND
25	GND	26	SATA TXP1
27	USB DATA7P	28	SATA TXN1
29	USB DATA7N	30	GND

31	GND	32	SATA RXP1
33	Power LED+	34	SATA RXN1
35	Power LED-	36	GND
37	GND	38	USB3 VCC
39	GND	40	USB DATA3N
41	INTERRUPT	42	USB DATA3P
43	GND	44	USB3 GND
45	TXD#4	46	RXD#4
47	RTS#4	48	CTS#4
49	DSR#4	50	DTR#4

Jumper Settings

To set jumper positions, place the jumper shunt over the pins designated in the table (SHORT) or remove (NC) it from the jumper pins and store for future use. Default settings are indicated with a star sign (★).

JP1

CMOS RAM charge/discharge setup

JP1	Function
1-2 Short	Charge ★
2-3 Short	Clear CMOS

SW1

LVDS 24bit Single & Dual Channel Selection

SW1(2-3-4)	Function
Off-Off-Off	24bit 2ch(Scalar Mode)
Off-On-Off	24bit 1ch(By Pass Mode)★
On-Off-Off	18bit 1ch(By Pass Mode)

JP5

LVDS 24bit Single & Dual Channel Voltage Selection

JP5	Function
1-2 Short	Scalar Mode(Dual Channel)
2-3 Short	By Pass Mode(Single Channel)★

Note:

Please adjust the correct voltage according to the way that SW1 choose.

JP6

LVDS Panel VDD Input Voltage Selection

JP6	Function
2-4 Short	3.3V ★
3-4 Short	12V
4-6 Short	5V

JP7

LVDS Panel Backlight Enable Voltage Selection

JP7	Function
1-2 Short	3.3V ★
2-3 Short	5V

J23

LVDS Panel Backlight Control Selection

J23	Function
1-2 Short	HIGH ★
2-3 Short	LOW

JP9**CF Card Master Slave Selection**

JP9		Function
1-2 Short		Master ★
1-2 Open		Slave

JP10**COM1 RI Function Selection**

JP10			Function
1-2	3-4	5-6	
Short			+5V output
	Short		RI function ★
		Short	+12V output

JP11**COM2 RI Function Selection**

JP11			Function
1-2	3-4	5-6	
Short			+5V output
	Short		RI function ★
		Short	+12V output

JP12**COM5 RI Function Selection**

JP12			Function
1-2	3-4	5-6	
Short			+5V output
	Short		RI function ★
		Short	+12V output

JP13**COM6 RI Function Selection**

JP13.			Function
1-2	3-4	5-6	
Short			+5V output
	Short		RI function ★
		Short	+12V output

Note:

Wrong voltage selection may damage the COM Port device. Please survey COM port device's RI before setup this jumper setting.

JP14**Key Board & Mouse Voltage**

JP14	Function
1-2 Short	VCC ★
1-2 Open	N VCC

SW2**H/W RAID Mode Selection**

SW2	Function
0	Port multiplier(to clear RAID)
1	JBOD mode ★
2	RAID 1 mode
3	RAID 0 mode

JP17**Auto Rebuilding Selection**

JP17	Function
1-2 short	ENABLE ★
2-3 short	DISABLE

JP18**Auto Amplifier SE or BTL mode Section**

JP18	Function
Open	MTL mode ★
Short	SE mode

J25**USB Port (J24) Voltage Section**

J25	Function
1-2 short	+5V
2-3 short	5VSB ★

Chapter 5 Transfer Boards and I/O Ports Configuration

Powered USB Board: Connector Allocation

The powered USB Board transfers signals from main board to external 12V powered and 24V powered USB ports.

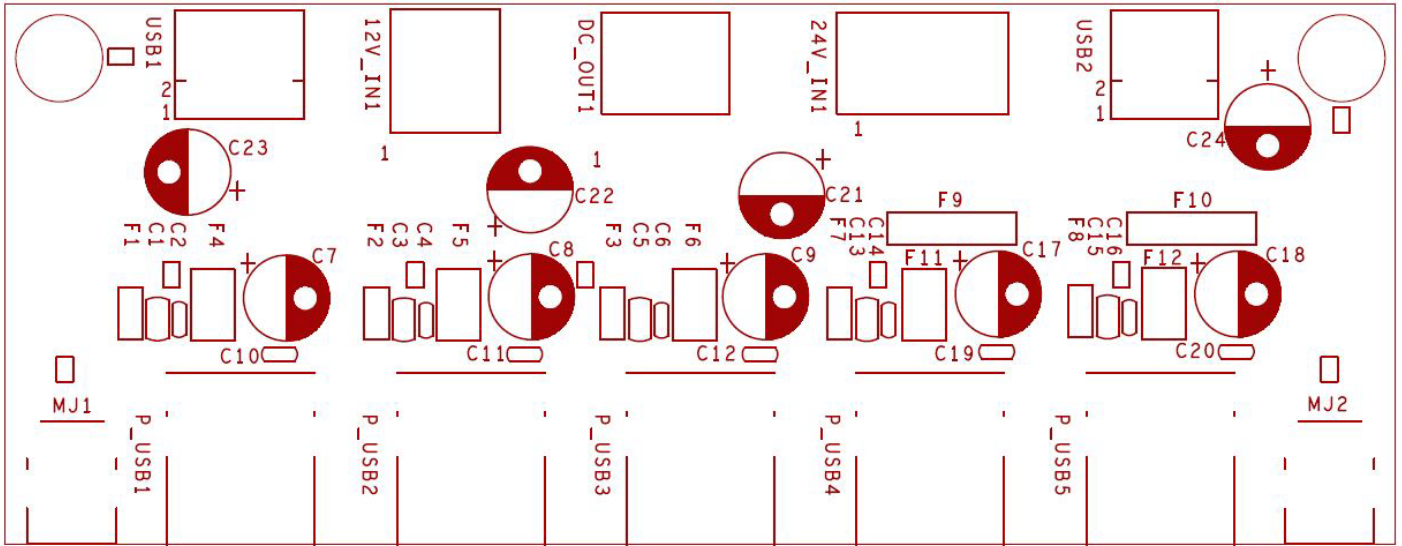

Connector Allocations

Connector	Function
USB1/USB2	Client USB Connector
12V_IN1	12V Power Connector
24V_IN1	24V Power Connector
P_USB1/2/3/4/5	5 Ports Powered USB connectors

LVDS to VGA Transfer Board: Connector Allocation

The LVDS to VGA Transfer Board transfers signals from main board to external 2nd VGA port (ABOX-201-1DV only).

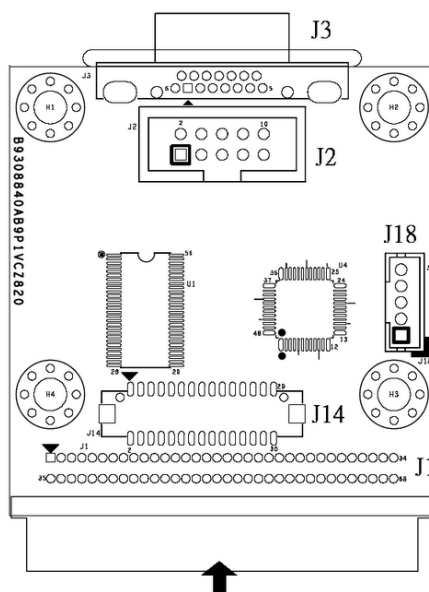

Connector Allocations

Connector	Function
J1	Main Connector
J2	VGA Box Header
J3	VGA Connector (DB15)
J14	LVDS Signal Connector
J18	Power Connector

External 2nd VGA Port: Connector Pin Definitions

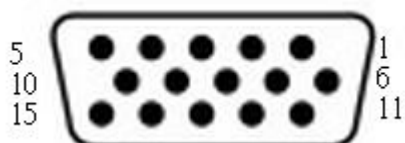

PIN No.	Description	PIN No.	Description
1	RED	2	GREEN
3	BLUE	4	NC
5	GND	6	GND
7	GND	8	GND
9	NC	10	GND
11	NC	12	NC
13	HSYNC	14	VSYNC
15	NC		

Chapter 6 Software Setup

Pre-Installation Requirements

This system comes with a variety of drivers for different operating systems. A software CD is included in the package contents. The following section documents the procedures used to install the peripheral.

1. Insert software CD into a system.
2. Run the setup.exe file on the CD.
3. Click **【Select Product】** to select your POS model.

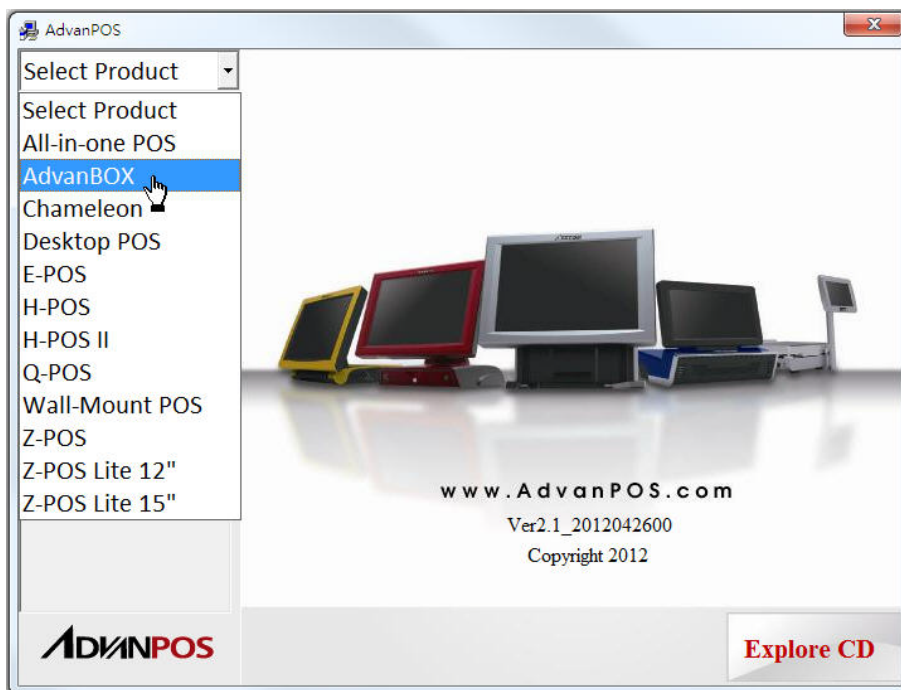

4. Click **【Select System】** to select your operating system.

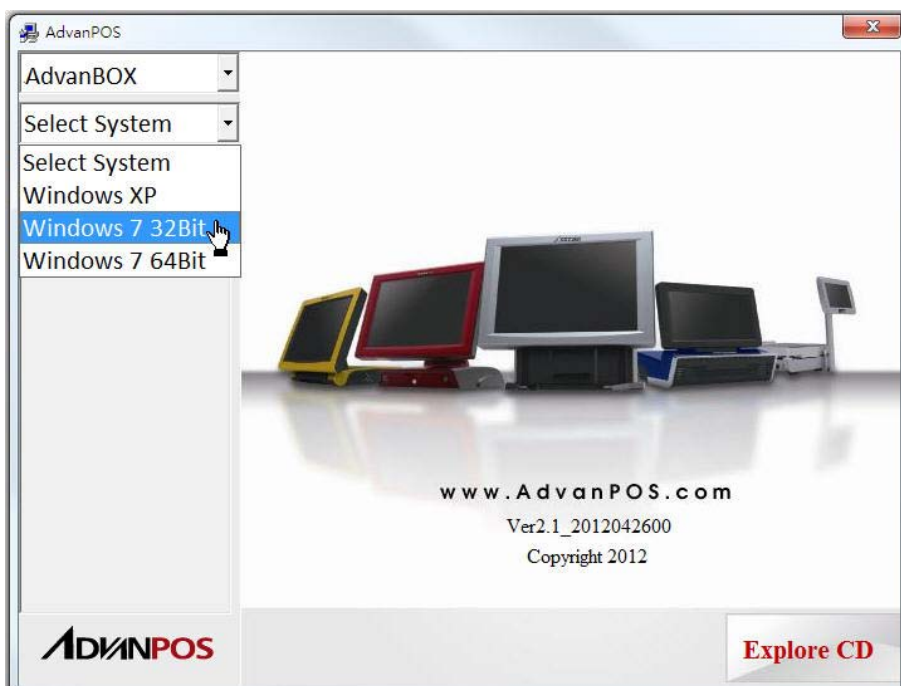



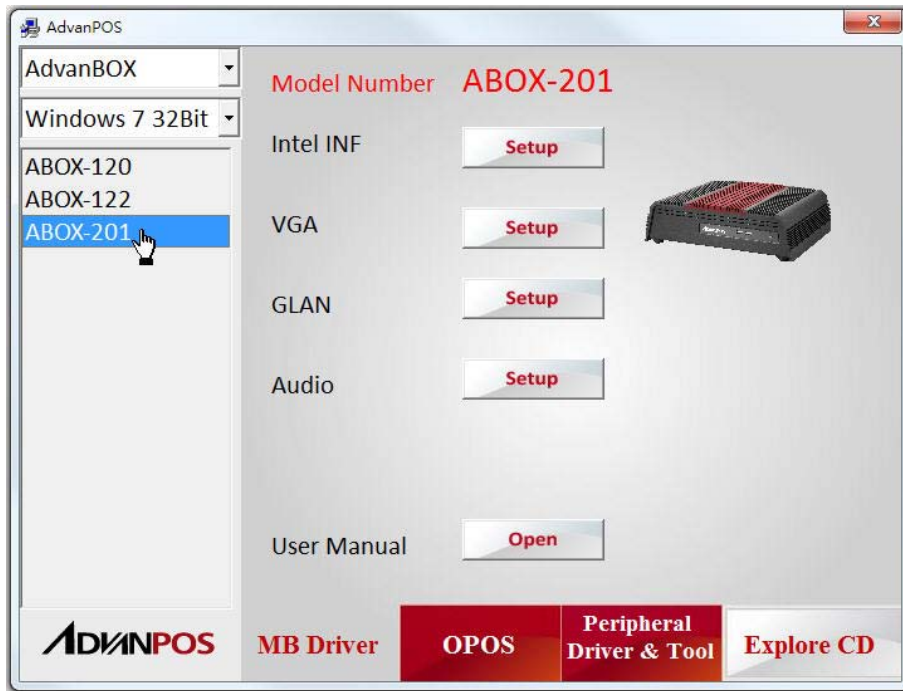

5. Select your POS model Number.



6. Select the peripheral driver that you want to install and then follow on-screen instructions to install your driver or refer to following procedures specifying how every driver is to be installed.

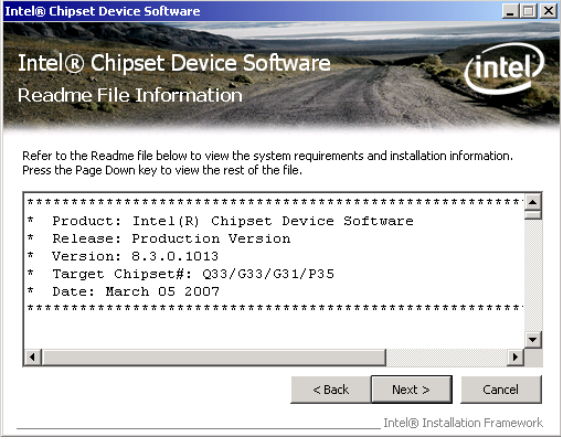

Intel Chipset Driver Installation

	
<p>1. Click the Next button on the Welcome screen.</p>	<p>2. Click Yes on the License Agreement screen.</p>
	
<p>3. Click Next on the Information screen.</p>	<p>4. When installation is complete, click Finish.</p>

Intel Graphics Driver Installation

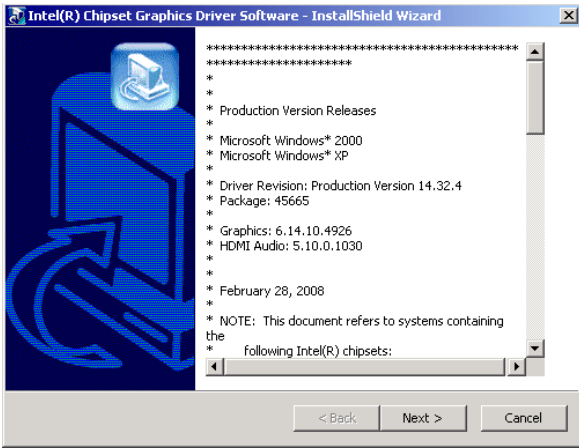

1. Click Next on the Startup screen.

2. Click Next on the Welcome screen.

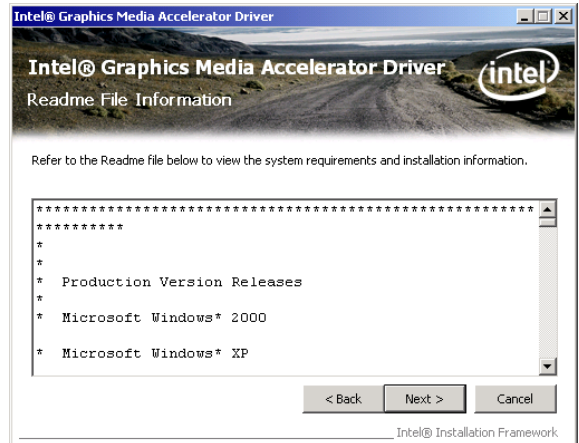
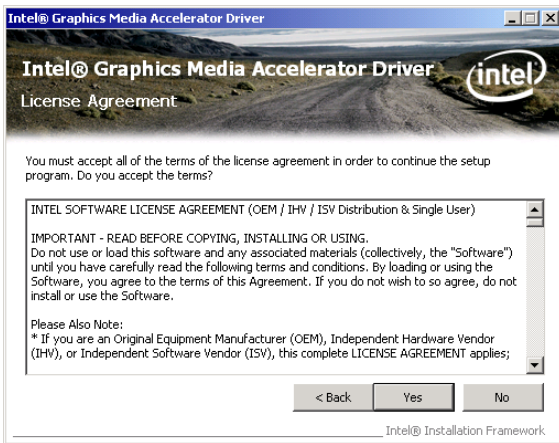

3. Click Yes on the License Agreement screen.

4. Click Next on the Information screen.

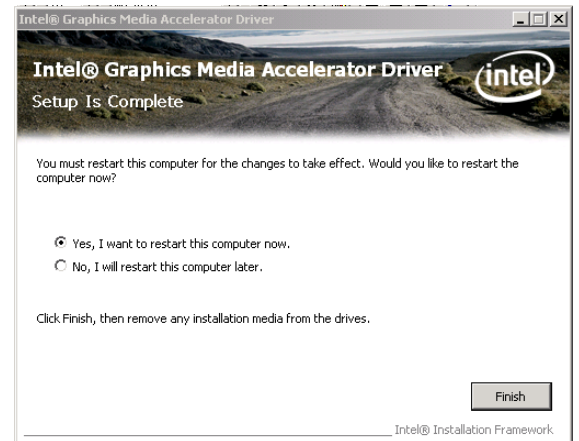
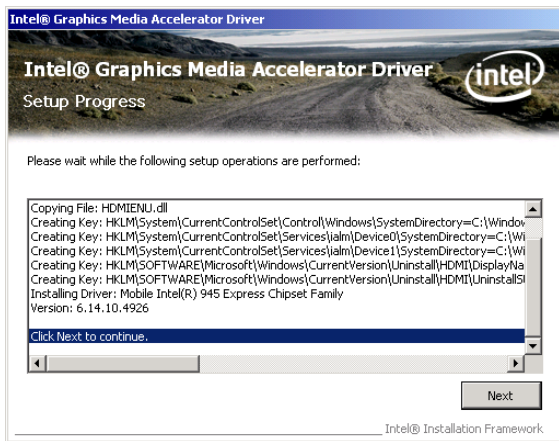

5. Click Next on the Setup Progress screen.

6. When installation is complete, click Finish and restart the system.

Audio Driver Installation

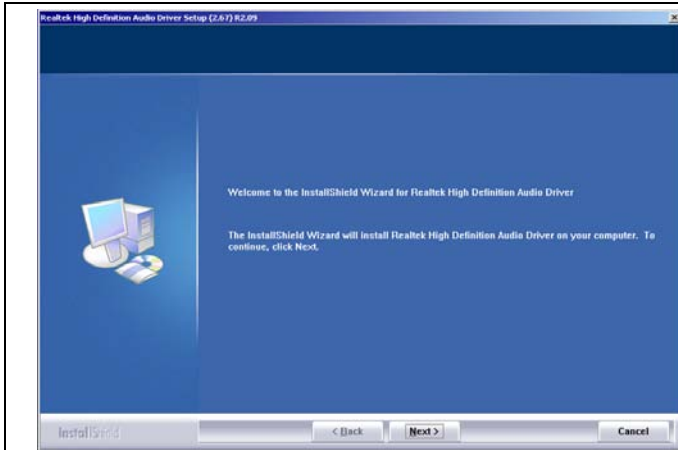

1. Click Next on the Welcome screen.

2. When installation is complete, click Finish to restart the system.

Ethernet Driver Installation for Windows XP

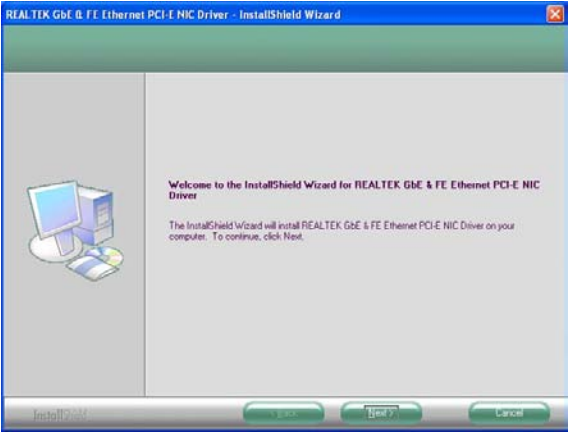
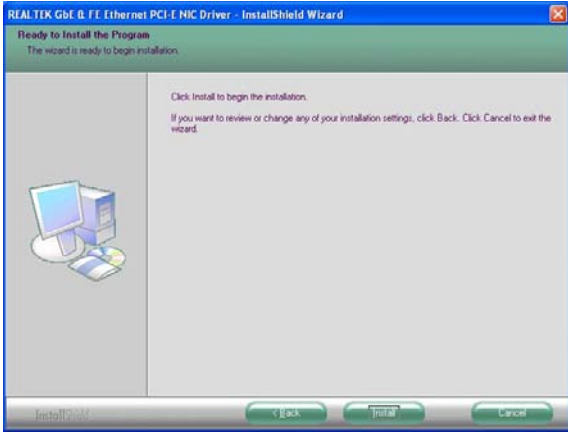
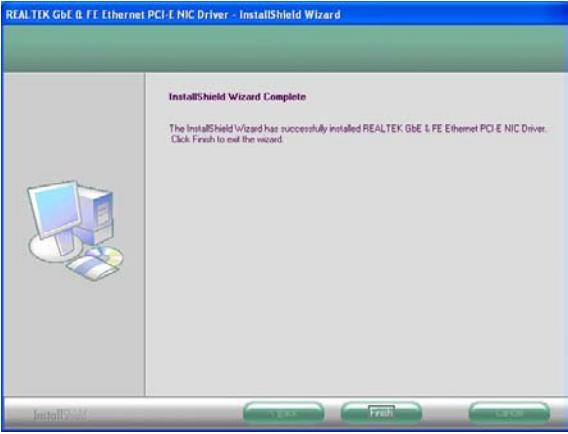
	
<p>1. Click Next.</p>	<p>2. Click Install.</p>
	
<p>3. Click Finish.</p>	

Ethernet Driver Installation for Windows 7

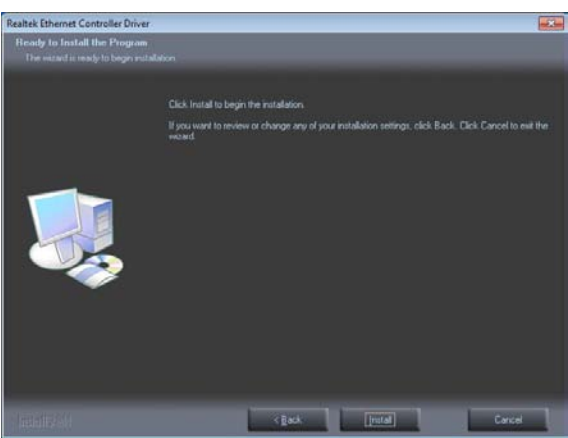
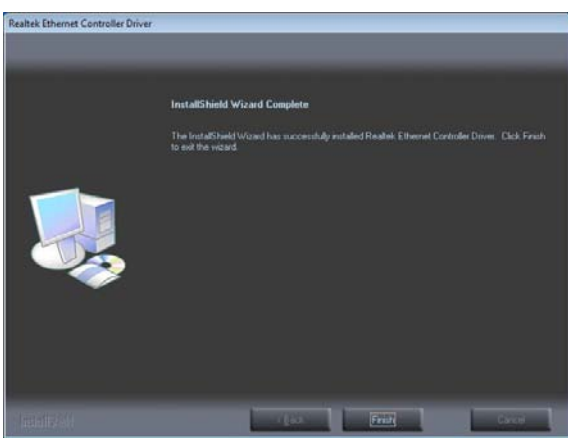
	
<p>1. Click Install.</p>	<p>2. Click Finish.</p>

AdvanPOS System Driver Installation (required for Cash Drawer)

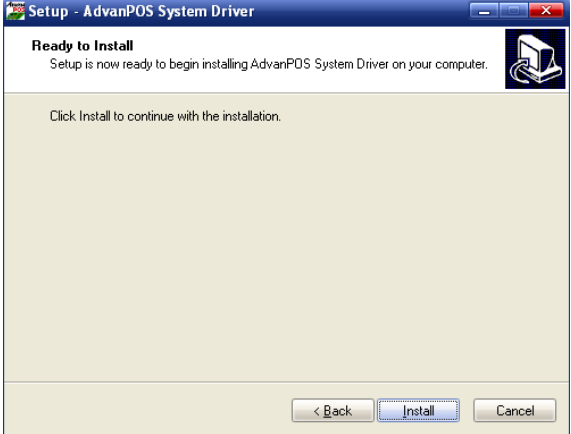
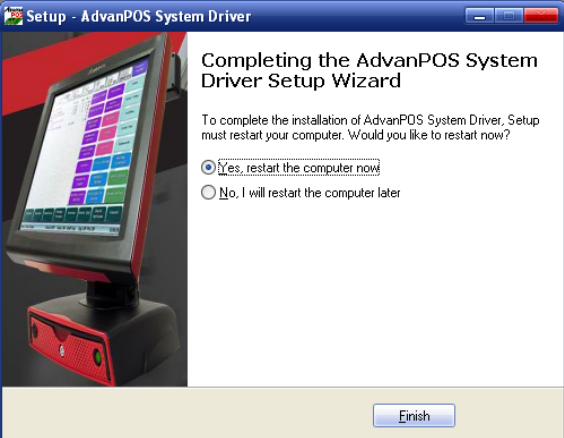
	
<p>1. Click Next on the Welcome screen.</p>	<p>2. Click Install on the Ready to Install screen.</p>
	
<p>3. Click Finish on the Completing installation screen. A system restart is required to complete the installation.</p>	

OPOS CCO Driver Installation

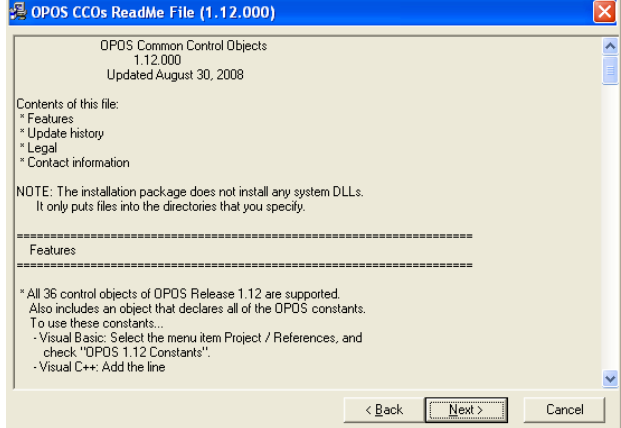
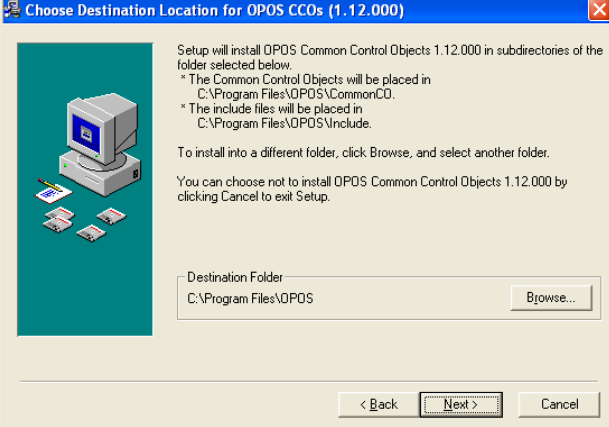
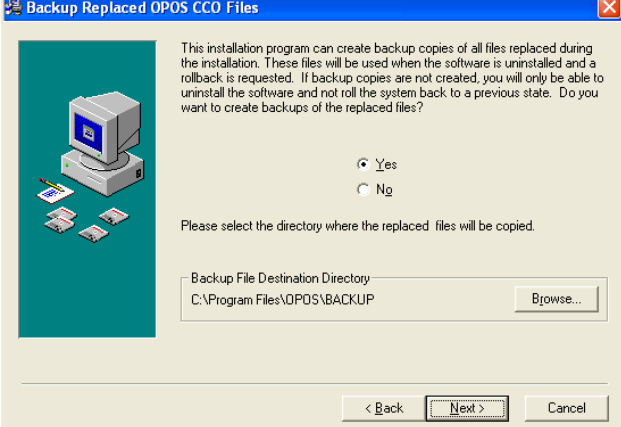
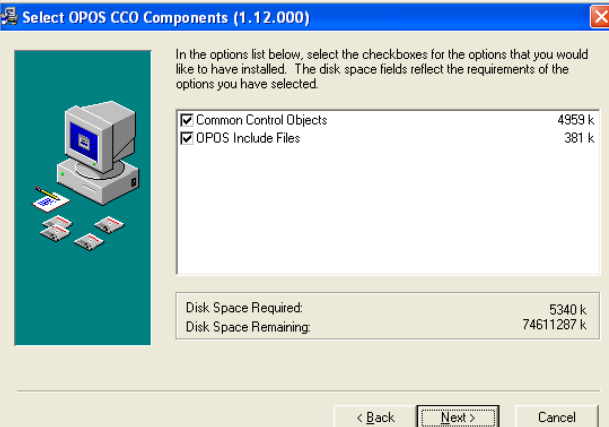
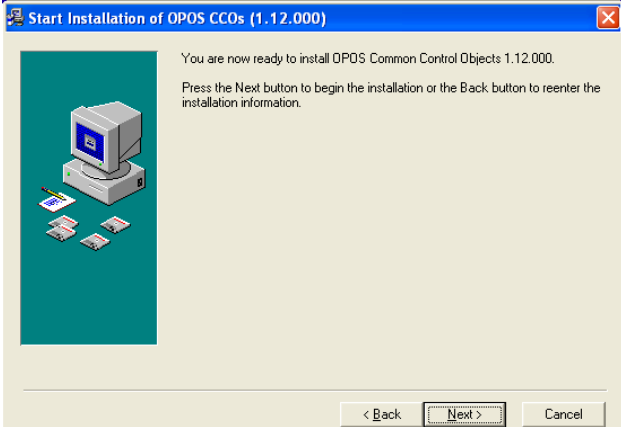

The OPOS driver for the ABOX-201-1 (ABOX-2120) supports the Cash Drawer, MSR, I-Button (KeyLock), RFID and VFD (Line- Display). Before installing the OPOS driver, please make sure the AdvanPOS System Driver has been installed.

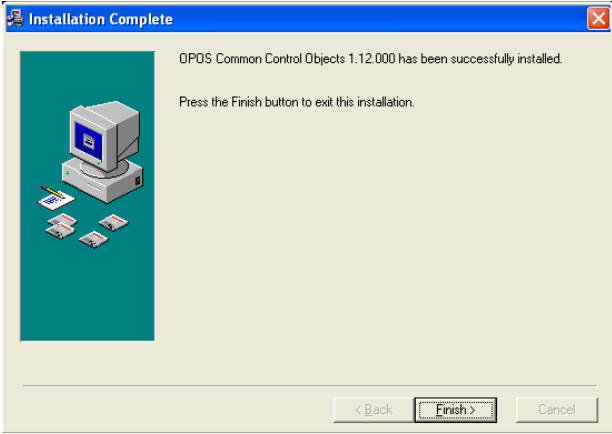
	
<p>1. Click Next on the Welcome screen.</p>	<p>2. Click Next on the ReadMe screen.</p>
	
<p>3. Select the Destination Location and click Next.</p>	<p>4. Click Yes to backup the CCO files and select backup file destination directory, then click Next.</p>
	
<p>5. Select Common Control Objects and OPOS Include Files, then click Next.</p>	<p>6. Click Next on the Start Installation screen.</p>

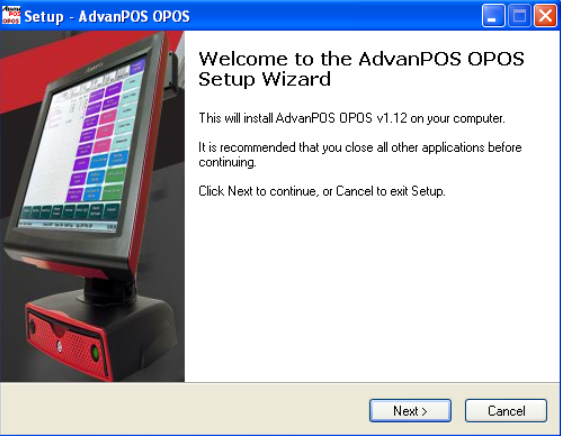
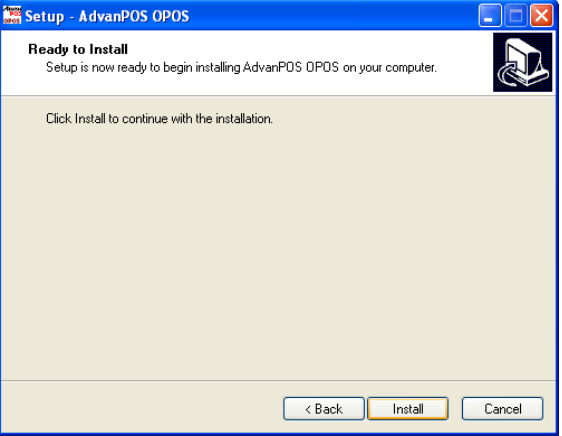

7. Click Finish on the Installation Complete screen.

AdvanPOS OPOS Driver Installation

	
<p>1. Click Next on the Welcome screen.</p>	<p>2. Click Install on the Setup screen.</p>
	
<p>3. Click Finish on the Completing installation screen.</p>	

Appendix A. Sample C++ Cash Drawer Code for Windows

**NOTE:**

Requires installation of System Driver. Refer to the System Driver Installation section for instructions.

1. Open Cash Drawer

```
// IOCTL Codes
#define GPD_TYPE 56053
#define ADV_OPEN_CTL_CODE CTL_CODE(GPD_TYPE, 0x900, METHOD_BUFFERED, FILE_ANY_ACCESS)
#define ADV_STATUS_CTL_CODE CTL_CODE(GPD_TYPE, 0x901, METHOD_BUFFERED, FILE_ANY_ACCESS)

void OpenDrawer(UCHAR uWhichDrawer)
{
    // uWhichDrawer = 1 => CD#1, uWhichDrawer = 2 => CD#2
    HANDLE hFile;
    BOOL bRet;
    UCHAR uDrawer = uWhichDrawer;

    // Open the driver
    hFile = CreateFile("\\\\.\\ADVSYS",
                      GENERIC_WRITE | GENERIC_READ,
                      FILE_SHARE_READ | FILE_SHARE_WRITE, NULL,
                      OPEN_EXISTING, FILE_ATTRIBUTE_NORMAL, 0);

    if (m_hFile == INVALID_HANDLE_VALUE)
    {
        AfxMessageBox("Unable to open Cash Drawer Device Driver!");
        return;
    }

    // Turn on the Cash Drawer Output (Fire the required solenoid)
    bRet = DeviceIoControl(hFile, ADV_CD_OPEN_CTL_CODE,
                          &uDrawer, sizeof(uDrawer),
                          NULL, 0,
                          &ulBytesReturned, NULL);

    if (bRet == FALSE || ulBytesReturned != 1)
    {
        AfxMessageBox("Failed to write to cash drawer driver");
        CloseHandle(hFile);
        return;
    }

    CloseHandle(hFile);
}
```

2. Get Cash Drawer Status

```
void GetDrawerState()
{
    HANDLE hFile;
    BOOL bRet;

    // Open the driver
    hFile = CreateFile(TEXT("\\\\.\\ADVSYS"),
                      GENERIC_WRITE | GENERIC_READ,
                      FILE_SHARE_READ | FILE_SHARE_WRITE, NULL,
                      OPEN_EXISTING, FILE_ATTRIBUTE_NORMAL, 0);

    if (m_hFile == INVALID_HANDLE_VALUE)
```

```

{
    AfxMessageBox("Unable to open Cash Drawer Device Driver!");
    return;
}

// Read the CD status
bRet = DeviceIoControl(hFile, ADV_CD_STATUS_CTL_CODE,
    NULL, 0
    &ReadByte, sizeof(ReadByte),
    &ulBytesReturned, NULL);

if (bRet == FALSE || ulBytesReturned != 1)
{
    AfxMessageBox("Failed to Read from cash drawer driver");
    CloseHandle(hFile);
    return;
}
else
{
    AfxMessageBox(ReadByte ? "Drawer Open" : "Drawer Closed");
}

CloseHandle(hFile);
}

```

Appendix B. Sample VB.NET Cash Drawer Code for Windows



NOTE:

Requires installation of System Driver. Refer to the System Driver Installation section for instructions.

```
Private Declare Function CreateFile Lib "kernel32" Alias "CreateFileA" (ByVal lpFileName As String, ByVal dwDesiredAccess As Integer, ByVal dwShareMode As Integer, ByVal lpSecurityAttributes As IntPtr, ByVal dwCreationDisposition As Integer, ByVal dwFlagsAndAttributes As Integer, ByVal hTemplateFile As IntPtr) As Integer
Private Declare Function DeviceIoControl Lib "kernel32" (ByVal hDevice As IntPtr, ByVal dwIoControlCode As Integer, ByVal lpInBuffer As Byte, ByVal nInBufferSize As Integer, ByVal lpOutBuffer As Byte, ByVal nOutBufferSize As Integer, ByVal lpBytesReturned As Long, ByVal lpOverlapped As Integer) As Integer
Private Declare Function CloseHandle Lib "kernel32" (ByVal hObject As Long) As Integer

Public Shared Function CTL_CODE(ByVal DeviceType As Integer, ByVal func As Integer, ByVal Method As Integer, ByVal Access As Integer) As Integer
    Return (DeviceType << 16) Or (Access << 14) Or (func << 2) Or Method
End Function

Dim DeviceHandle As Integer
Const GENERIC_READ As Long = &H80000000, GENERIC_WRITE As Long = &H40000000
Const FILE_SHARE_READ As Long = &H1, FILE_SHARE_WRITE As Long = &H2
Const OPEN_EXISTING As Long = &H3, FILE_ATTRIBUTE_NORMAL As Long = &H80
Const INVALID_HANDLE_VALUE As Long = &HFFFFFFFF

Const ADVPORT_TYPE As Long = 40000, METHOD_BUFFERED As Long = 0, FILE_ANY_ACCESS As Long = 0
Dim ADV_OPEN_CTL_CODE As Long = CTL_CODE(ADVPORT_TYPE, &H900, METHOD_BUFFERED, FILE_ANY_ACCESS)
Dim ADV_STATUS_CTL_CODE As Long = CTL_CODE(ADVPORT_TYPE, &H901, METHOD_BUFFERED, FILE_ANY_ACCESS)

Private Sub Form1_Load(ByVal sender As System.Object, ByVal e As System.EventArgs) Handles MyBase.Load
    DeviceHandle = CreateFile("\\.\ADVSYS", GENERIC_READ Or GENERIC_WRITE, FILE_SHARE_READ Or FILE_SHARE_WRITE, 0, OPEN_EXISTING, FILE_ATTRIBUTE_NORMAL, 0)
    If DeviceHandle = INVALID_HANDLE_VALUE Then
        'Failed to Open Cash Drawer Driver
        Timer1.Enabled = False
        MsgBox("Error opening ADVSYS.sys. Error = " & Err.LastDllError)
    End If
End Sub

Private Sub Button1_Click(ByVal sender As System.Object, ByVal e As System.EventArgs) Handles Button1.Click
    Dim iBytesRtn As Integer
    Dim iRet As Integer, iDrawer As Integer

    ' Open Drawer #1
    iDrawer = &H1
    iRet = DeviceIoControl(DeviceHandle, ADV_OPEN_CTL_CODE, iDrawer, 4, 0, 0, iBytesRtn, 0)
    If (iRet = 0 Or iBytesRtn <> 1) Then
        MsgBox("Error opening ADVSYS.sys. Error = " & Err.LastDllError)
    End If
End Sub

Private Sub Button2_Click(ByVal sender As System.Object, ByVal e As System.EventArgs) Handles Button2.Click
    Dim iBytesRtn As Integer
    Dim iRet As Integer, iDrawer As Integer

    ' Open Drawer #2
    iDrawer = &H2
    iRet = DeviceIoControl(DeviceHandle, ADV_OPEN_CTL_CODE, iDrawer, 4, 0, 0, iBytesRtn, 0)
```



```

If (iRet = 0 Or iBytesRtn <> 1) Then
    MsgBox("Error opening ADVSYS.sys. Error = " & Err.LastDllError)
End If
End Sub
Private Sub Timer1_Tick(ByVal sender As System.Object, ByVal e As System.EventArgs) Handles Timer1.Tick
    Dim iBytesRtn As Integer
    Dim iRet As Integer, iStatus As Integer

    ' Get Drawer Status
    iRet = DeviceIoControl(DeviceHandle, ADV_STATUS_CTL_CODE, 0, 0, iStatus, 4, iBytesRtn, 0)
    If (iRet = 0 Or iBytesRtn <> 1) Then
        MsgBox("Error opening ADVSYS.sys. Error = " & Err.LastDllError)
    End If
    If (iStatus = 0) Then
        StatusText.Text = "Cash Drawer(s) Closed"
    Else
        StatusText.Text = "Cash Drawer(s) Open"
    End If
End Sub

```

Appendix C. Sample VB6.0 Cash Drawer Code for Windows



NOTE:

Requires installation of System Driver. Refer to the System Driver Installation section for instructions.

Option Explicit On

```
Private Declare Function CreateFile Lib "kernel32" Alias "CreateFileA" (ByVal lpFileName As String, ByVal dwDesiredAccess As Long, ByVal dwShareMode As Long, ByVal lpSecurityAttributes As SECURITY_ATTRIBUTES, ByVal dwCreationDisposition As Long, ByVal dwFlagsAndAttributes As Long, ByVal hTemplateFile As Long) As Long
Private Declare Function DeviceIoControl Lib "kernel32" (ByVal hDevice As Long, ByVal dwIoControlCode As Long, ByVal lpInBuffer As Any, ByVal nInBufferSize As Long, ByVal lpOutBuffer As Any, ByVal nOutBufferSize As Long, ByVal lpBytesReturned As Long, ByVal lpOverlapped As OVERLAPPED) As Long
Private Declare Function CloseHandle Lib "kernel32.dll" (ByVal hObject As Long) As Long
```

'CreateFile Custom Variables

```
Private Type SECURITY_ATTRIBUTES
    nLength As Long
    lpSecurityDescriptor As Long
    bInheritHandle As Long
End Type
```

'DeviceIoControl Custom Variables

```
Private Type OVERLAPPED
    Internal As Long
    InternalHigh As Long
    offset As Long
    OffsetHigh As Long
    hEvent As Long
End Type
```

```
Dim DeviceHandle As Integer
Dim SA As SECURITY_ATTRIBUTES
Dim SA1 As OVERLAPPED
Dim ADV_OPEN_CTL_CODE As Long
Dim ADV_STATUS_CTL_CODE As Long
```

```
Private Const GENERIC_READ As Long = &H80000000
Private Const GENERIC_WRITE As Long = &H40000000
Private Const FILE_SHARE_READ As Long = &H1
Private Const FILE_SHARE_WRITE As Long = &H2
Private Const OPEN_EXISTING As Long = &H3
Private Const FILE_ATTRIBUTE_NORMAL As Long = &H80
Private Const INVALID_HANDLE_VALUE As Long = &HFFFFFFFF
```

```
Private Const METHOD_BUFFERED As Long = 0, FILE_ANY_ACCESS As Long = 0
```

```
Private Function CTL_CODE(ByVal lngDevFileSys As Long, ByVal lngFunction As Long, ByVal lngMethod As Long, ByVal lngAccess As Long) As Long
    CTL_CODE = (lngDevFileSys) Or (lngAccess * (2 ^ 14)) Or (lngFunction * (2 ^ 2)) Or lngMethod
End Function
```

```

Private Sub Form_Load()
    '-1673527296 Come from c code (40000 <<16)
    ADV_OPEN_CTL_CODE = CTL_CODE(-1673527296, &H900, METHOD_BUFFERED, FILE_ANY_ACCESS)
    ADV_STATUS_CTL_CODE = CTL_CODE(-1673527296, &H901, METHOD_BUFFERED, FILE_ANY_ACCESS)

    DeviceHandle = CreateFile("\\.\ADVSYS", GENERIC_READ Or GENERIC_WRITE, FILE_SHARE_READ Or
FILE_SHARE_WRITE, SA, OPEN_EXISTING, FILE_ATTRIBUTE_NORMAL, 0)
    If DeviceHandle = INVALID_HANDLE_VALUE Then
        'Failed to Open Cash Drawer Driver
        MsgBox("Error opening ADVSYS.sys. Error = " & Err.LastDllError)
    End If
End Sub

Private Sub Command1_Click()
    Dim iBytesRtn As Long
    Dim iRet As Integer, iDrawer As Integer

    ' Open Drawer #1
    iDrawer = &H1
    iRet = DeviceIoControl(DeviceHandle, ADV_OPEN_CTL_CODE, iDrawer, 4, 0, 0, iBytesRtn, SA1)
    If (iRet = 0 Or iBytesRtn <> 1) Then
        MsgBox("Error opening ADVSYS.sys. Error = " & Err.LastDllError)
    End If
End Sub

Private Sub Command2_Click()
    Dim iBytesRtn As Long
    Dim iRet As Integer, iDrawer As Integer

    ' Open Drawer #2
    iDrawer = &H2
    iRet = DeviceIoControl(DeviceHandle, ADV_OPEN_CTL_CODE, iDrawer, 4, 0, 0, iBytesRtn, SA1)
    If (iRet = 0 Or iBytesRtn <> 1) Then
        MsgBox("Error opening ADVSYS.sys. Error = " & Err.LastDllError)
    End If
End Sub

Private Sub Timer1_Timer()
    Dim iBytesRtn As Long
    Dim iRet As Integer, iStatus As Integer

    ' Get Drawer Status
    iRet = DeviceIoControl(DeviceHandle, ADV_STATUS_CTL_CODE, 0, 0, iStatus, 4, iBytesRtn, SA1)
    If (iRet = 0 Or iBytesRtn <> 1) Then
        Timer1.Enabled = False
        MsgBox("Error opening ADVSYS.sys. Error = " & Err.LastDllError)
    End If
    If (iStatus = 0) Then
        Label1.Caption = "Cash Drawer(s) Closed"
    Else
        Label1.Caption = "Cash Drawer(s) Open"
    End If
End Sub

```